



การไฟฟ้านครหลวง  
PROVINCIAL ELECTRICITY AUTHORITY

**PROVINCIAL ELECTRICITY AUTHORITY**

**TECHNICAL SPECIFICATION DIVISION**

**THREE-PHASE TRANSFORMERS FOR 22 kV AND 33 kV 50 Hz DISTRIBUTION SYSTEMS**

**WITH ABILITY TO WITHSTAND SHORT CIRCUIT**

Specification No. RTRN-035/2561

Approved date : 16/12/2562

Rev. No. : 0

Form No.

Page 1 of 1

**เอกสารเพิ่มเติมแนบท้ายรายละเอียดสเปค  
(ADDENDUM)**

เอกสารเพิ่มเติมแนบท้ายรายละเอียดสเปค (ADDENDUM) นี้ให้ถือเป็นส่วนหนึ่งของสเปคอ้างอิงเลขที่ RTRN-035/2561

**การทดสอบ Lightning impulse test**

กำหนดรายละเอียดการทดสอบ lightning impulse test เพิ่มเติมในหัวข้อ 1e.2.2 Test procedure of Type test and Short-circuit withstand test ข้อ (3) และ 1e.5 Acceptance test items and acceptance test procedures ดังต่อไปนี้

**(1) Test connections**

For the lightning impulse test on the LV windings ( $U_m \leq 1.1$  kV), PEA will accept test connections as the following:

**CASE 1:**

The impulse test sequence is applied to each of line terminals of the tested winding in succession. The other line terminals of the transformer shall be earthed directly or through an impedance, or

**CASE 2:**

The impulse test is applied to all the LV terminals (including the LV neutral) connected together with the higher voltage terminals earthed.

**(2) Test voltage**

The standard lightning-impulse voltage and tolerances shall be in accordance with the IEC 60060-1 as the table below:

Description	HV	LV
Test voltage value	125 kV, peak $\pm 3\%$ (for 22 kV system) 170 kV, peak $\pm 3\%$ (for 33 kV system)	30 kV, peak $\pm 3\%$
Front time	1.2 $\mu s \pm 30\%$	
Time to half-value	50 $\mu s \pm 20\%$	
Relative overshoot magnitude	not exceed 10 %	

The minimum information on the waveshape in the test report shall consist of test voltage,



การไฟฟ้าส่วนภูมิภาค  
PROVINCIAL ELECTRICITY AUTHORITY

# PROVINCIAL ELECTRICITY AUTHORITY

## TECHNICAL SPECIFICATION DIVISION

### THREE-PHASE TRANSFORMERS FOR 22 kV AND 33 kV 50 Hz DISTRIBUTION SYSTEMS WITH ABILITY TO WITHSTAND SHORT CIRCUIT

Specification No. RTRN-035/2561

Approved date: ๐ 4 NOV 2020

Rev. No.: 0

Form No.

Page 1 of 2

#### เอกสารเพิ่มเติมแนบท้ายรายละเอียดสเปค 2

#### (ADDENDUM 2)

เอกสารเพิ่มเติมแนบท้ายรายละเอียดสเปค (ADDENDUM 2) นี้ให้ถือเป็นส่วนหนึ่งของสเปคอ้างอิงเลขที่ RTRN-035/2561

#### การทดสอบเพื่อการตรวจรับ (Acceptance test)

รายละเอียดการทดสอบเพื่อการตรวจรับนี้ ให้ใช้แทนหัวข้อ 1e.5.2 Acceptance test procedures ในสเปค

- (1) การทดสอบเพื่อการตรวจรับตามหัวข้อ 1e.5.1(1) ถึง (7) และหัวข้อที่ (11)

ให้สุ่มตัวอย่างจากหม้อแปลงที่จัดส่งในแต่ละงวด โดยสุ่มตัวอย่างแต่ละรายการ (Item) ที่มีหมายเลขรหัสพัสดุเดียวกัน เกณฑ์การพิจารณาให้เป็นไปตามตารางที่ 1 ดังนี้

#### ตารางที่ 1

จำนวนหม้อแปลงที่ จัดส่งแต่ละงวด <sup>(1)</sup> (เครื่อง)	จำนวนตัวอย่าง ที่ส่งทดสอบเพื่อการตรวจรับ (เครื่อง)	จำนวนตัวอย่างสูงสุด ที่ยอมรับให้ทดสอบไม่ผ่าน (เครื่อง)
2 ถึง 15	2	0
16 ถึง 25	3	0
26 ถึง 90	5	0
91 ถึง 150	8	0
151 ถึง 500	13	1
มากกว่า 500	20	1

<sup>(1)</sup> จำนวนหม้อแปลงที่จัดส่งในแต่ละงวด แยกตามหมายเลขรหัสพัสดุ

ทั้งนี้ หากจำนวนหม้อแปลงที่ไม่ผ่านการทดสอบมากกว่าจำนวนตัวอย่างสูงสุดที่ยอมรับให้ทดสอบไม่ผ่านตามตารางที่ 1 ให้คณะกรรมการตรวจรับพัสดุฯ ดำเนินการตามขั้นตอนการตรวจรับพัสดุในหลักเกณฑ์การตรวจรับพัสดุ กฟภ.

- (2) การทดสอบเพื่อการตรวจรับตามหัวข้อ 1e.5.1(8), (9) และ (10) สำหรับงวดแรกของสัญญา ที่ผ่านการทดสอบในข้อ (1) มาแล้ว

2.1 ให้ทดสอบเพื่อการตรวจรับในแต่ละหัวข้อ โดยพิจารณาจากจำนวนหม้อแปลงทั้งหมดในสัญญาในแต่ละรายการ (Item) ที่มีหมายเลขรหัสพัสดุเดียวกัน ตามตารางที่ 2 ดังนี้



การไฟฟ้าส่วนภูมิภาค  
Provincial Electricity Authority

**PROVINCIAL ELECTRICITY AUTHORITY**

**TECHNICAL SPECIFICATION DIVISION**

**THREE-PHASE TRANSFORMERS FOR 22 KV AND 33 KV 50 HZ DISTRIBUTION SYSTEMS  
WITH ABILITY TO WITHSTAND SHORT CIRCUIT**

Specification No. RTRN-035/2561

Approved date: **04 NOV 2020**

Rev. No.: 0

Form No.

Page 2 of 2

ตารางที่ 2

จำนวนหม้อแปลงทั้งหมด ในสัญญา <sup>(2)</sup> (เครื่อง)	หัวข้อการทดสอบเพื่อการตรวจรับที่ต้องทดสอบ		
	Temperature-rise test	Full wave lightning impulse test	Short-circuit withstand test
0 ถึง 9	ไม่ทดสอบ	ไม่ทดสอบ	ไม่ทดสอบ
10 ถึง 29	ทดสอบ	ไม่ทดสอบ	ไม่ทดสอบ
30 ถึง 189	ทดสอบ	ทดสอบ	ไม่ทดสอบ
190 ขึ้นไป	ทดสอบ	ทดสอบ	ทดสอบ

<sup>(2)</sup> จำนวนหม้อแปลงทั้งหมดในสัญญา แยกตามหมายเลขรหัสพัสดุ

2.2 ให้ทดสอบเพื่อการตรวจรับกับหม้อแปลงที่ส่งในงวดแรกของสัญญา โดยสุ่มตัวอย่างแต่ละรายการ (Item) ที่มีหมายเลขรหัสพัสดุเดียวกัน และใช้ตัวอย่างเดียวกันกับตัวอย่างที่ผ่านการทดสอบตามหัวข้อ 1e.5.1(1) ถึง (7) และหัวข้อที่ 1e.5.1(11) มาแล้ว เพื่อสละระยะเวลาการทดสอบ ให้สามารถแยกทดสอบในแต่ละหัวข้อโดยใช้หม้อแปลงตัวอย่างที่แตกต่างกันได้ เช่น หากทดสอบหัวข้อ 1e.5.1(8) (9) และ (10) ให้สามารถใช้ 3 ตัวอย่าง (3 Serial numbers) ได้ โดยเกณฑ์การพิจารณาให้เป็นไปตามตารางที่ 3 ดังนี้

ตารางที่ 3

หัวข้อการทดสอบตรวจรับ (1e.5.1)	จำนวนตัวอย่าง ที่ส่งทดสอบเพื่อการตรวจรับ (เครื่อง)	จำนวนตัวอย่างสูงสุด ที่ยอมรับให้ทดสอบไม่ผ่าน (เครื่อง)
(8) Temperature-rise test	1	0
(9) Full wave lightning impulse test	1	0
(10) Short-circuit withstand test	1	0

ทั้งนี้ หากจำนวนหม้อแปลงที่ไม่ผ่านการทดสอบมากกว่าจำนวนตัวอย่างสูงสุดที่ยอมรับให้ทดสอบไม่ผ่านตามตารางที่ 3 ให้คณะกรรมการตรวจรับพัสดุฯ ดำเนินการตามขั้นตอนการตรวจรับพัสดุฯ ในหลักเกณฑ์การตรวจรับพัสดุฯ กฟภ.

หลังจากการทดสอบในแต่ละหัวข้อ คู่สัญญาจะต้องทำให้หม้อแปลงที่นำไปเป็นตัวอย่างทุกตัว สมบูรณ์พร้อมใช้งานเหมือนเดิมก่อนส่งคืนให้กับ PEA โดยไม่คิดค่าใช้จ่าย

**หมายเหตุ**

กรณี กฟภ. เป็นผู้ประมาณการจัดหาหม้อแปลงที่มีพิกัดกำลังไฟฟ้าสูงกว่า 250 kVA ให้ทดสอบเพื่อการ





**PROVINCIAL ELECTRICITY AUTHORITY**

**ELECTRICAL AND MECHANICAL DIVISION**

**THREE-PHASE TRANSFORMERS FOR 22 KV AND 33 KV 50 Hz DISTRIBUTION SYSTEMS  
WITH ABILITY TO WITHSTAND SHORT CIRCUIT**

Specification No. RTRN-035/2561	Approved date: 04 NOV 2021	Rev. No.: 0	Form No.	Page 1 of 1
---------------------------------	----------------------------	-------------	----------	-------------

**เอกสารเพิ่มเติมแนบรายละเอียดสเปค 3  
(ADDENDUM 3)**

เอกสารเพิ่มเติมแนบรายละเอียดสเปค (ADDENDUM) นี้ให้ถือเป็นส่วนหนึ่งของสเปคหม้อแปลงไฟฟ้าระบบ  
จำหน่ายเลขที่ RTRN-035/2561

รายละเอียดห้องปฏิบัติการทดสอบนี้ ให้ใช้แทนหัวข้อ 1e.3 Acknowledged independent testing  
laboratories ในสเปค

**1e.3 Acknowledged independent testing laboratories**

The type test and short-circuit withstand test shall be conducted or inspected by the  
acknowledged testing laboratories/institutes as follows:

- (1) Laboratories/institutes which are members of the Short-circuit Testing Liaison (STL) or  
independent laboratories/institutes which are accredited according to TIS 17025 or  
ISO/IEC 17025 with the scope of accreditation covered the relevant test items,  
standards, and equipment.

The certification and scope of accreditation of the independent laboratories/institutes  
shall be submitted with the bid for consideration.

The bidders or manufacturers who are accredited according to TIS 17025 or ISO/IEC  
17025 preferring to carry out the type tests and short-circuit withstand test of the  
transformers with the laboratories or by the manufacturers themselves, the tests shall  
be inspected by Thailand's national laboratories, institutes, universities, and electric  
utilities in (2) and other laboratories, institutes, universities, or electric utilities  
approved by PEA.

- (2) Thailand's national laboratories, institutes, universities, and electric utilities, as follow:
  - Electricity Generating Authority of Thailand (EGAT)
  - Thonburi Electrical Power Laboratory (TEPL)
- (3) Other laboratories, institutes, universities, or electric utilities approved by PEA. In this  
case, the detail of the test facilities of the laboratories shall be submitted to PEA for  
approval before proceeding the tests and before the bid closing date. PEA reserves  
the right to send representatives to inspect and witness the tests with the cost of the  
bidders or manufacturers.





การไฟฟ้านครหลวง  
PROVINCIAL ELECTRICITY AUTHORITY

# PROVINCIAL ELECTRICITY AUTHORITY

## TECHNICAL SPECIFICATION DIVISION

### THREE-PHASE TRANSFORMERS FOR 22 kV AND 33 kV 50 Hz DISTRIBUTION SYSTEMS WITH ABILITY TO WITHSTAND SHORT CIRCUIT

Specification No. RTRN-035/2561

Approved date : 30/05/2562

Rev. No. : 5

Form No. 02-38

Page 1 of 32

#### Invitation to Bid No.:

**C Material, equipment, and specifications for THREE-PHASE TRANSFORMERS FOR 22 kV AND 33 kV 50 Hz DISTRIBUTION SYSTEMS WITH ABILITY TO WITHSTAND SHORT CIRCUIT**

**C1 General material and packing instructions**

Additional to the general instructions, the following shall be observed:

**1a Scope**

These specifications cover three-phase transformers, oil-immersed, natural self-cooled, power range from 50 kVA to 2,000 kVA, designed and constructed to withstand without damage the thermal and dynamic effects of external short circuits, suitable for outdoor installation on 22 kV and 33 kV 50 Hz distribution systems.

**1b Standards**

The transformers shall be manufactured and tested in accordance with the following standards:

Thailand Industrial Standard (TIS)

TIS 384: 2543                      Power Transformers

International Electrotechnical Commission (IEC)

IEC 60076-1:2011              Power transformers– Part 1: General

IEC 60076-2:2011              Power transformers – Part 2: Temperature rise for liquid-immersed transformers

IEC 60076-3:2013              Power transformers – Part 3: Insulation levels, dielectric tests and external clearances in air

IEC 60076-5:2006              Power transformers – Part 5: Ability to withstand short circuit

IEC 60296: 2012                Fluids for electrotechnical applications – Unused mineral insulating oils for transformers and switchgear

International Organization for Standardization

ISO 12944-5:2007              Paints and varnishes - Corrosion protection of steel structures by protective paint systems - Part 5: Protective paint systems

LV bushings shall be in accordance with the DIN 42530. HV bushings shall be in accordance with the DIN 42531.

And all other relevant standards, unless otherwise specified in these specifications.

P.E.A. will also accept the transformers and accessories tested in accordance with the later edition of the



การไฟฟ้านครหลวง  
PROVINCIAL ELECTRICITY AUTHORITY

# PROVINCIAL ELECTRICITY AUTHORITY

## TECHNICAL SPECIFICATION DIVISION

### THREE-PHASE TRANSFORMERS FOR 22 kV AND 33 kV 50 Hz DISTRIBUTION SYSTEMS WITH ABILITY TO WITHSTAND SHORT CIRCUIT

Specification No. RTRN-035/2561

Approved date : 30/05/2562

Rev. No. : 5

Form No. 02-38

Page 2 of 32

PEA will also accept the type test report in accordance with the previous edition of the above standards, if there is no significant change in any test items or no additional test item(s) compared with the above standards. On the other hand, if there is significant change in any test items or there are any additional test items, the previous edition type test report with the additional test report(s) of the significant change test item(s) and/or additional test item(s) will be also accepted.

#### 1c Principal requirement

##### 1c.1 Service conditions and installation

The transformers shall be designed and constructed for outdoor installation and operation under the following conditions:

Altitude	: up to 1,000 m above sea level
Ambient air temperature	: 50°C, maximum
	: 40°C, monthly average, of the hottest month
Relative humidity	: up to 94 %
Climate condition	: tropical climate

**Table 1 Transformer installation**

Transformer Rating ( kVA )	Installation
50 – 250	on concrete pole and on platform
315 – 1,500	on platform and on concrete foundation
2,000	on concrete foundation

##### 1c.2 Oil preservation system

The transformers of 50 kVA to 500 kVA shall be permanently sealed and completely oil filled system (without gas cushion) type (usually corrugated tank). The transformer tank cover shall be bolt tightened to the tank with suitable gasket sealing.

The transformers of 630 kVA to 2,000 kVA shall be conservator system type.

##### 1c.3 Rating

###### 1. Rated power

The rated power, on continuous operation, for transformers shall be as follows:

50 kVA	250 kVA	500 kVA	1,000 kVA	2,000 kVA
100 kVA	315 kVA	630 kVA	1,250 kVA	
160 kVA	400 kVA	800 kVA	1,500 kVA	



การไฟฟ้านครหลวง  
PROVINCIAL ELECTRICITY AUTHORITY

**PROVINCIAL ELECTRICITY AUTHORITY**

**TECHNICAL SPECIFICATION DIVISION**

**THREE-PHASE TRANSFORMERS FOR 22 kV AND 33 kV 50 Hz DISTRIBUTION SYSTEMS  
WITH ABILITY TO WITHSTAND SHORT CIRCUIT**

Specification No. RTRN-035/2561

Approved date : 30/05/2562

Rev. No. : 5

Form No. 02-3S

Page 3 of 32

**2. Rated voltages**

The rated voltage of windings is given in Table 2.

**Table 2 Rated voltage**

Rated Primary Voltage	Rated Secondary Voltage
22 kV, 33 kV	416/240 V

**3. Rated frequency: 50 Hz**

**1c.4 Core and windings**

The cores and windings of transformers shall be as follows:

**Table 3 Core and windings**

Transformer Rating (kVA)	Construction of Core	- HV and LV Windings shall be made of	Construction of Windings	
			HV winding	LV winding
50-2,000	According to manufacturer's standard	copper only	According to manufacturer's standard	According to manufacturer's standard

**1c.5 Tappings**

The primary windings of transformers shall be provided with full capacity of externally-operated off-circuit tap changers.

Tapping range:  $\pm 2 \times 2.5\%$  of rated primary voltage

The externally-operated off-circuit tap changer shall be designed for de-energized operation with the operating handle brought out through the cover of the tank. The operating handle shall have provision for locking and shall give visual indication of the tapping position without unlocking.

The tap changer shall have a locking device to prevent improper use. The operating handle shall be rotated in clockwise direction from a high tap voltage to a lower tap voltage. The tap changer shall be provided with stops to identify the highest and lowest tap position. The tap changer positions shall be identified by the numbers in sequence. The number "1" shall be designated to the highest tap voltage. Consequently the number "5" indicates the lowest tap voltage. These identifications shall be in perfect correspondence to those indicated in the connection diagram on the nameplate. All five positions of the tap changer shall be operative positions.

The tap positions shall be indelibly marked with weather-proof paint and in a color which shall present distinctive contrast to the surrounding material.



การไฟฟ้านครหลวง  
PROVINCIAL ELECTRICITY AUTHORITY

# PROVINCIAL ELECTRICITY AUTHORITY

## TECHNICAL SPECIFICATION DIVISION

### THREE-PHASE TRANSFORMERS FOR 22 kV AND 33 kV 50 Hz DISTRIBUTION SYSTEMS WITH ABILITY TO WITHSTAND SHORT CIRCUIT

Specification No. RTRN-035/2561

Approved date : 30/05/2562

Rev. No. : 5

Form No. 02-38

Page 4 of 32

#### 1c.6 Connection symbol

50 kVA to 2,000 kVA transformers shall have connection symbol Dyn 11.

#### 1c.7 Losses and Short - circuit impedance

The specified or guaranteed losses plus positive tolerance, for each transformer unit shall not be more than the losses are shown in the **Table 4**.

Short-circuit impedance shall be measured on the principle tapping of 22 or 33 kV at ambient temperature then corrected to 75°C.

Short-circuit impedance of the offered transformers shall be as specified in the **Table 4** and have tolerance within  $\pm 10\%$  except for transformer rating 500 kVA, the short-circuit impedance at 75°C of transformer rating 500 kVA shall be 6.5 or more.

**Table 4 Losses and short circuit impedance**

Transformer Rating (kVA)	Watt Loss (W)		Load loss at 75°C	Short-circuit Impedance at 75°C (%)
	No-load loss, for system voltage of :			
	22 kV	33 kV		
50	110	170	875	4
100	180	260	1450	4
160	260	370	2000	4
250	360	520	2750	4
315	440	630	3250	4
400	520	750	3850	4
500	610	900	4600	6.5 or more
630	680	1050	5600	6
800	800	1150	7000	6
1,000	940	1300	9000	6
1,250	1150	1530	11000	6
1,500	1380	1850	13200	6
2,000	1800	2140	18000	6

#### 1c.8 Limits of temperature-rise, above 50°C ambient temperature

Of top oil : not exceeding 50 K

Of winding : not exceeding 55 K





การไฟฟ้านครหลวง  
PROVINCIAL ELECTRICITY AUTHORITY

**PROVINCIAL ELECTRICITY AUTHORITY**

**TECHNICAL SPECIFICATION DIVISION**

**THREE-PHASE TRANSFORMERS FOR 22 kV AND 33 kV 50 Hz DISTRIBUTION SYSTEMS  
WITH ABILITY TO WITHSTAND SHORT CIRCUIT**

Specification No. RTRN-035/2561

Approved date : 30/05/2562

Rev. No. : 5

Form No. 02-3S

Page 5 of 32

**1c.9 Insulation level**

The insulation level of HV windings, LV windings and connected parts of transformers shall be as specified in the **Table 5**:

**Table 5 Insulation level**

Nominal System Voltage (kV, r.m.s.)	Insulation Level	
	Impulse Test Voltage Full-wave (kV, peak)	Power Frequency Test Voltage, 1-min (kV, r.m.s.)
22	125	50
33	170	70
0.416/0.24	30	10

**1c.10 Bushings**

**1. Number and location**

Each transformer shall have three (3) high-voltage bushings and four (4) low-voltage bushings located on the cover of the tank.

Secondary neutral point of transformer shall be brought out by separate-insulated bushing(s) and loaded with rated current.

The HV bushings shall not be completed with the arcing horns.

**2. Material**

Transformer bushings shall be made of good commercial-grade wet-process porcelain.

The entire porcelain surface of the bushings that will be exposed after assembly shall be glazed.

The color of the glaze shall be brown.

**3. Electrical characteristics**

Transformer bushings shall be capable of withstanding the impulse and low-frequency voltage specified in the **Table 6**:

**Table 6 Electrical characteristics**

Bushings	Impulse Full Wave (kV, peak)	Low-frequency, 50 Hz (kV, r.m.s.)	
		Dry 1-minute	Wet 10-second
High-voltage bushings for 22 kV system	125	50	50
High-voltage bushings for 33 kV system	170	70	70
Low-voltage bushings	30	10	10



การไฟฟ้านครหลวง  
PROVINCIAL ELECTRICITY AUTHORITY

# PROVINCIAL ELECTRICITY AUTHORITY

## TECHNICAL SPECIFICATION DIVISION

### THREE-PHASE TRANSFORMERS FOR 22 kV AND 33 kV 50 Hz DISTRIBUTION SYSTEMS WITH ABILITY TO WITHSTAND SHORT CIRCUIT

Specification No. RTRN-035/2561

Approved date : 30/05/2562

Rev. No. : 5

Form No. 02-3S

Page 6 of 32

#### 4. Minimum Clearance

Safety clearance of Transformer bushings shall comply with minimum Clearance Criterion, which measurement between live part to live part or live part to ground shall be as follows.

- At least 225 mm for 22 kV System
- At least 320 mm for 33 kV System

#### 5. Test report

The bidders have to submit the test report of bushing with the bid in order to confirm the electrical characteristic in **Table 6 Electrical characteristics**, the bidders who cannot submit will be rejected. The test of bushing can be conducted by manufacturer or third party laboratories.

#### 1c.11 Terminal connectors

HV bushings shall be equipped with solderless clamp type connectors for aluminium conductor diameter range from 7.5 mm to 12.6 mm (sizes 35-95 mm<sup>2</sup>).

Only for 50 kVA to 1,250 kVA transformers: LV bushings shall be equipped with terminal pad connectors (stud type connectors are preferable), of high conductivity bronze and hot-tin dipped. The terminal pads shall be drilled in accordance with NEMA Standards (9/16" holes on 1 3/4" centers); each hole shall be furnished with one (1) bolt M12 x 60 mm (of at least 50 mm thread length), one (1) nut, two (2) flat washers, and one (1) lock washer; details of terminal pads shall be according to Drawing No. SA4-015/47002. The connectors shall be provided with mounting hardware (bolts, nuts, washers, and lock washers) of stainless steel or better.

Only for 1,500 kVA to 2,000 kVA transformers: LV bushings shall be equipped with solderless clamp type connectors (stud type connectors are preferable), of high conductivity bronze and hot-tin dipped, for aluminium and copper conductor sizes, and number of circuits take off shall be as **Table 7:**

**Table 7 Terminal connectors for 1,500 kVA to 2,000 kVA transformers**

Transformer Rating (kVA)	Applicable to Aluminium and Copper Conductors		Number of Circuits
	diameter range (mm)	sizes (mm <sup>2</sup> )	
1,500	18.4 - 29.2	240 - 500	4
2,000	18.4 - 29.2	240 - 500	6

The connectors shall be provided with mounting hardware (bolts, nuts, washers, and lock washers) of stainless steel or better. The details of connectors shall be according to Drawing No. SA4-015/47002.



**PROVINCIAL ELECTRICITY AUTHORITY**

**TECHNICAL SPECIFICATION DIVISION**

**THREE-PHASE TRANSFORMERS FOR 22 kV AND 33 kV 50 Hz DISTRIBUTION SYSTEMS  
WITH ABILITY TO WITHSTAND SHORT CIRCUIT**

Specification No: RTRN-035/2561

Approved date : 30/05/2563

Rev. No. : 5

Form No. 02-3S

Page 7 of 32

**1c.12 Tank and Tank finish**

Tank and cover shall be constructed of welded steel plate suitable reinforced. The joints between the tank and cover shall be provided with suitable flanges properly bolted together with gaskets.

Tank cover shall have 90° downward bent edges on all sides to protect the gasket under the top cover from direct exposure to weather.

Gaskets between metal surfaces shall be set in grooves or held in position by retainers so arranged that all parts are bolted metal-to-metal. The gaskets shall be made of resilient material which will not deteriorate under the action of hot oil and will remain oil-tight. Gaskets of such material which can be easily damaged by overpressing are not acceptable.

The transformer tank shall be finished with mounting bracket for surge arrester (Surge arrester polymer housing type supplied by PEA) and shall be furnished with three (3) earthing terminal provided for ground leads of surge arrester, see Drawing No. SA4-015/50008.

The bidders have to give the transformer's tank dimensions which passed type test in **2a. Performance data and guarantee of three-phase transformer (Page 29 of 32)**.

Tolerance of the transformer's tank dimensions for the purposed transformer shall be within +3 percent of the declared dimensions which given by the bidders in above information. Otherwise shall be rejected.

The distance between tank cover (Top plate) and fins which is installed the earthing terminal for surge arrester shall not less than 200 mm.

The manufacturer's serial number shall be dented on transformer tank cover.

The manufacture shall prepare 3 mm diameter holes for security seals threading. The first position, the hole shall be drilled at the right last bolt which fix tank and cover of transformer and the second position, the hole shall be drilled at the top right of transformer nameplate as **Figure 1**.

The security seals will be installed by PEA after any transformers pass the witness test or acceptance test or others depend on PEA's committee.

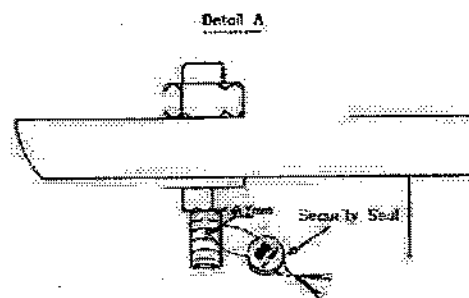
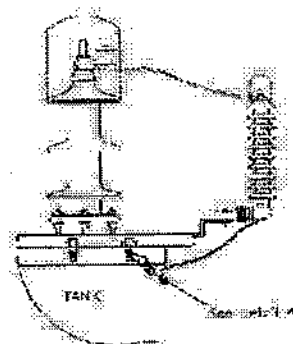



**PROVINCIAL ELECTRICITY AUTHORITY**

**TECHNICAL SPECIFICATION DIVISION**

**THREE-PHASE TRANSFORMERS FOR 22 kV AND 33 kV 50 Hz DISTRIBUTION SYSTEMS  
WITH ABILITY TO WITHSTAND SHORT CIRCUIT**

Specification No. RTRN-035/2561

Approved date : 30/05/2562

Rev. No. : 5

Form No. 02-3S

Page 8 of 32

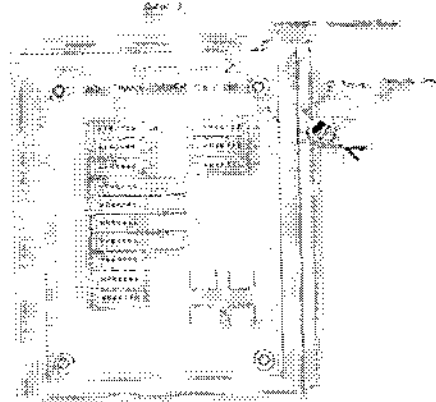

Note : The hole shall be drilled by manufacturer and thread with security seal by PEA

**Figure 1 Security seal installation**

**1c.12.1 Painting system**

**1. Interior surface**

Interior surface shall be finished oil resistant paint or varnish.

**2. Exterior surface**

The painting system will be suitable for an exterior servicing at medium atmospheric-corrosivity category is as C3, and system number is as A.3.08 in accordance with ISO 12944-5 Table A.3.

The coating system shall be in accordance with the ISO 12944-5 as following:

- Primer coat: The number of coats is one (1) or two (2) coats of Epoxy (Misc) Anti-Corrosive Primer, the dry film thickness shall not less than 80 µm.
- Subsequent coat(s): The number of coats is two (2) to three (3) of Epoxy Intermediate and Polyurethane topcoat with RAL 7036 gray color.
- The total number of coats is two (2) to four (4) coats and the dry film thickness of coating system shall not less than 160 µm.

**3. Dry film thickness test and test report**

The dry film thickness shall be spot checked for each layer of coating. The position of spot checks is specified as **Figure 2** for transformers of permanently sealed type, and **Figure 3** for transformers of conservator system type.



**PROVINCIAL ELECTRICITY AUTHORITY**

**TECHNICAL SPECIFICATION DIVISION**

**THREE-PHASE TRANSFORMERS FOR 22 KV AND 33 KV 50 Hz DISTRIBUTION SYSTEMS  
WITH ABILITY TO WITHSTAND SHORT CIRCUIT**

Specification No. RTRN-035/2561

Approved date : 30/05/2563

Rev. No. : 5

Form No. 02-38

Page 9 of 32

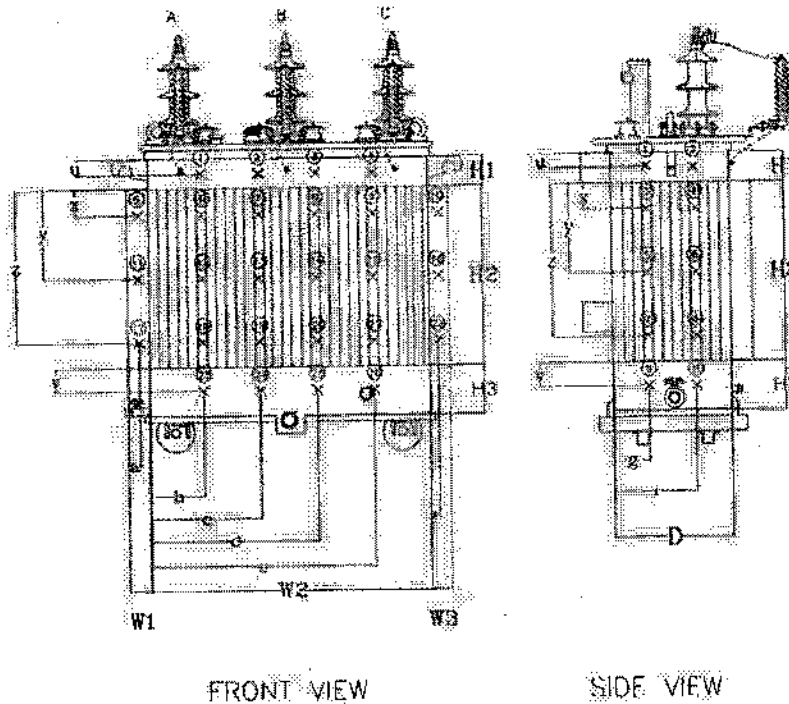

**Figure 2 The position of spot checking for transformers of permanently sealed type.**

The distance for spot checking of permanently sealed type is as Table 8:

**Table 8 Distance for spot checking of permanently sealed type**

Symbols	Length	Symbols	Length
a	About 1/2 of width (W1)	u	About 1/2 of height (H1)
b	About 1/5 of width (W2)	v	About 1/2 of height (H3)
c	About 2/5 of width (W2)	x	About 1/4 of height (H2)
d	About 3/5 of width (W2)	y	About 2/4 of height (H2)
e	About 4/5 of width (W2)	z	About 3/4 of height (H2)
f	About 1/2 of width (W3)		
g	About 1/3 of depth (D)		
i	About 2/3 of depth (D)		





**PROVINCIAL ELECTRICITY AUTHORITY**

**TECHNICAL SPECIFICATION DIVISION**

**THREE-PHASE TRANSFORMERS FOR 22 kV AND 33 kV 50 Hz DISTRIBUTION SYSTEMS**

**WITH ABILITY TO WITHSTAND SHORT CIRCUIT**

Specification No. RTRN-035/2561

Approved date: 30/05/2562

Rev. No. : 5

Form No. 02-3S

Page 10 of 32

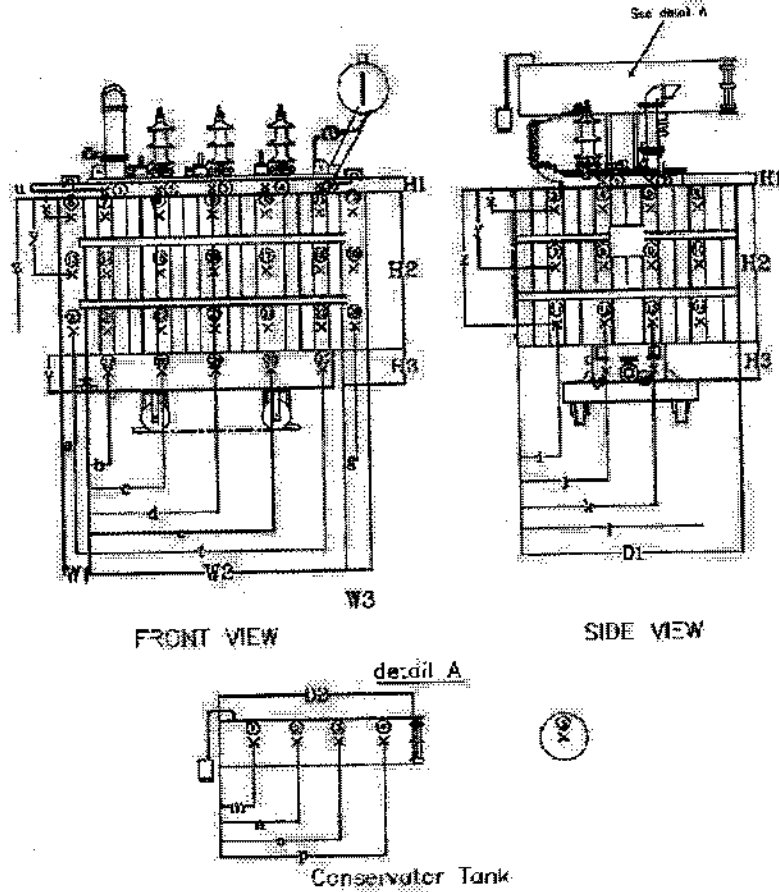

**Figure 3** The position for spot checking for transformers of conservator system type.

The distance for spot checking of conservator system type is as **Table 9**:

**Table 9** Distance for spot checking of conservator system type

Symbols	Length	Symbols	Length
a	About 1/2 of height (W1)	m	About 1/5 of depth (D2)
b	About 1/6 of height (W2)	n	About 2/5 of depth (D2)
c	About 2/6 of height (W2)	o	About 3/5 of depth (D2)
d	About 3/6 of height (W2)	p	About 4/5 of depth (D2)
e	About 4/6 of height (W2)	u	About 1/2 of height (H1)
f	About 5/6 of height (W2)	v	About 1/4 of width (H3)
g	About 1/2 of height (W3)	x	About 1/4 of width (H2)
i	About 1/5 of depth (D1)	y	About 2/4 of width (H2)
j	About 2/5 of depth (D1)	z	About 3/4 of width (H2)
k	About 3/5 of depth (D1)		
l	About 4/5 of depth (D1)		





การไฟฟ้าส่วนภูมิภาค  
PROVINCIAL ELECTRICITY AUTHORITY

**PROVINCIAL ELECTRICITY AUTHORITY**

**TECHNICAL SPECIFICATION DIVISION**

**THREE-PHASE TRANSFORMERS FOR 22 kV AND 33 kV 50 Hz DISTRIBUTION SYSTEMS  
WITH ABILITY TO WITHSTAND SHORT CIRCUIT**

Specification No. RTRN-035/2561

Approved date : 30/05/2562

Rev. No. : 5

Form No. 02-3S

Page 12 of 32

**1c.13 Marking**

PEA's code number and word "SHORT CIRCUIT WITHSTAND" shall be painted, in orange, on the transformer tank (for transformer having no conservator) or on the conservator tank (for transformer having conservator) at the position that enables a clear observation, and also be legibly and durably inscribed on the metal part of nameplate. The code number and dimensions of each letter to be marked shall be given by PEA after the final of bid consideration.

**1c.14 Accessories**

The 50 kVA to 2,000 kVA transformers shall be furnished and equipped with the following accessories:

1. HV and LV bushings, with terminal connectors
2. Bird guard cap (bushing cover), ultra-violet and track resistant material, e.g. polypropylene, neoprene, etc; which is suitable for exposure to sunlight
3. Earthing terminal for surge arrester, with solderless clamp type connector suitable for flexible copper insulated ground lead size 16 mm<sup>2</sup>, 430 mm long. (See Drawing No. SA4-015/50008)
4. Tap changer
5. Thermometer pocket, transformers shall have a thermometer pocket to allow the measuring of the top-oil temperature. This pocket shall be placed as shown in the EN 50216-4 (type A1). The pocket shall be provided with a corrosion-proof cap. The thread shall be protected with silicone-grease. Dimensions of the thermometer pocket in mm are shown as **Figure 4**.

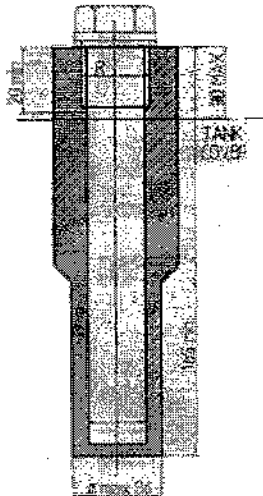

**Figure 4 Dimensions of thermometer pockets**

6. Nameplate with connection diagram
7. Oil drain valve with plug or cap, installed at the lower part of the tank
8. Sludge drain plug, installed at the bottom of the tank



การไฟฟ้าส่วนภูมิภาค  
PROVINCIAL ELECTRICITY AUTHORITY

**PROVINCIAL ELECTRICITY AUTHORITY**

**TECHNICAL SPECIFICATION DIVISION**

**THREE-PHASE TRANSFORMERS FOR 22 kV AND 33 kV 50 Hz DISTRIBUTION SYSTEMS  
WITH ABILITY TO WITHSTAND SHORT CIRCUIT**

Specification No. RTRN-035/2561

Approved date : 30/05/2562

Rev. No. : 5

Form No. 02-3S

Page 13 of 32

9. Earthing terminal, with solderless clamp type connector suitable for steel stranded conductor diameter of 9.0 mm (size 50 mm<sup>3</sup>); complete with lockwasher of stainless steel or better.
10. Lifting lugs
11. Lifting eyes on the cover
12. Oil level gauge
13. Compression type cable lug, for aluminium conductor diameter of 7.5-9.0 mm (sizes 35-50 mm<sup>2</sup>), suitable for connecting between HV bushing and surge arrester lead conductor.
14. Only for 50 kVA to 250 kVA transformers: Pressure relief valve on the tank cover, oil filling plug on the tank cover, and supporting lugs for hanging the transformer tank to pole by using two (2) M16 machine bolts.  
The lugs shall have 600 mm spacing; 500 mm or 400 mm spacing may be used when tank height will not permit the 600 mm dimension. (See Drawing No. SA4-015/50008)  
Only for 315 to 500 kVA transformers: Pressure relief valve on the tank cover, and oil filling plug on the tank cover.  
Only for 630 kVA to 2,000 kVA transformers: Pressure relief valve on the tank cover, oil conservator with dehydrating breather and oil level gauge. The cylinder of dehydrating breather shall be of transparent glass. The dehydrating breather shall be easy replaced and filled with silica-gel not less than 1.0 kg.
15. Only for 315 kVA to 2,000 kVA transformers: Transport rollers
16. Only for 1,000 kVA to 2,000 kVA transformers:
  - (a) Dial type thermometer with adjustable contact(s)
  - (b) Double float Buchholz relay having two (2) contacts (for alarm and tripping)
17. Other necessary accessories according to manufacturer's design.

**1c.15 Initial oil filling**

The transformers shall be supplied with initial oil filling. The oil shall be according to IEC 60296, high-quality, clean and dry.

The oil shall be free from Polychlorinated biphenyls (PCB).

**1c.16 Nameplate**

The following minimum nameplate information shall be legibly and durably inscribed on the metal part of nameplate:

- (1) Manufacturer's name
- (2) Manufacturer's serial number
- (3) Year of manufacture



การไฟฟ้านครหลวง  
PROVINCIAL ELECTRICITY AUTHORITY

**PROVINCIAL ELECTRICITY AUTHORITY**

**TECHNICAL SPECIFICATION DIVISION**

**THREE-PHASE TRANSFORMERS FOR 22 kV AND 33 kV 50 Hz DISTRIBUTION SYSTEMS  
WITH ABILITY TO WITHSTAND SHORT CIRCUIT**

Specification No. RTRN-035/2561

Approved date : 30/05/2562

Rev. No. : 5

Form No. 02-3S

Page 14 of 32

- (5) Contract number and/or PO number
- (6) Number of phases
- (7) Rated frequency in Hz
- (8) Rated power in kVA
- (9) Rated voltage in V
- (10) Rated current in A
- (11) Rated secondary short-circuit withstand current in kA r.m.s.
- (12) Tapping voltages in V
- (13) Connection symbol
- (14) Short-circuit impedance in %
- (15) Connection diagram
- (16) Type of cooling
- (17) Oil quantity in liters
- (18) Drain oil quantity in liters (for permanently sealed type)
- (19) Total weight in kg
- (20) Wording **"SHORT CIRCUIT WITHSTAND"**
- (21) Material of HV and LV winding such as copper winding, cooper foil etc.

**1c.17 Bushing location and terminal markings**

Bushing shall locate as shown in the figures below:

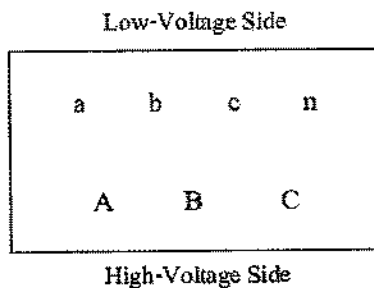

**Figure 5 50-250 kVA Tank top view**

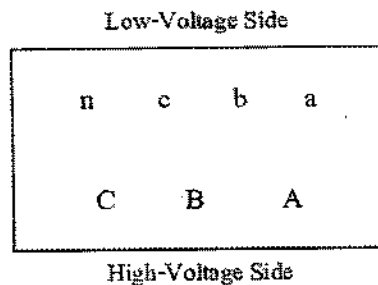





การไฟฟชาภชาชน  
PROVINCIAL ELECTRICITY AUTHORITY

# PROVINCIAL ELECTRICITY AUTHORITY

## TECHNICAL SPECIFICATION DIVISION

### THREE-PHASE TRANSFORMERS FOR 22 kV AND 33 kV 50 Hz DISTRIBUTION SYSTEMS WITH ABILITY TO WITHSTAND SHORT CIRCUIT

Specification No. RTRN-035/2561

Approved date : 30/05/2562

Rev. No. : 5

Form No. 02-3S

Page 15 of 32

The letters A, B, C, a, b, c, and n shall be durable marked on transformer tank beside bushings consequently. The height of the symbols shall not less than 30 mm.

Mark by sticker is not accepted.

#### 1c.18 Mass

For 50 kVA to 160 kVA transformers: Mass of complete transformer with oil and accessories shall not be more than 1,000 kg.

For 250 kVA transformers: Mass of complete transformer with oil and accessories shall not be more than 1,200 kg.

Tolerance of the mass of proposed complete transformers with oil shall be within  $\pm 5$  percent of the declared mass of transformer which passed type test given by the bidders in 2a Performance data and guarantee of three-phase transformer (Page 28 of 32) but the maximum mass shall not exceed the above allowable mass.

If the mass of complete transformers with oil more than  $\pm 5$  percent of the declared mass or exceed the above allowable mass, the transformers shall be rejected.

#### 1d Packing

For transformers manufactured outside the territories of Thailand, each transformer shall be seaworthy packed in individual export crate or wooden case which will not be returned.

For transformers manufactured within the territories of Thailand, each transformer shall be packed in individual crate or wooden case which will not be returned.

Only for 50 kVA to 160 kVA transformers for 22 kV systems and 50 kVA to 100 kVA transformers for 33 kV systems, each crate or wooden case shall be strong enough for stacking over with at least another one.

If the crate or wooden case is made of rubber wood (Yang-para), the wooden parts shall be treated with wood preservative.

The details of wood treatment shall be described.

#### 1e Tests and test reports

##### 1e.1 Routine test

Each transformer shall pass the manufacturer's standard routine tests, and also pass the following tests in accordance with the relevant standards:

- (1) Measurement of winding resistance (IEC 60076-1)
- (2) Measurement of voltage ratio and check of phase displacement (IEC 60076-1)
- (3) Measurement of short-circuit impedance and load loss (IEC 60076-1)



การไฟฟ้านครหลวง  
PROVINCIAL ELECTRICITY AUTHORITY

# PROVINCIAL ELECTRICITY AUTHORITY

## TECHNICAL SPECIFICATION DIVISION

### THREE-PHASE TRANSFORMERS FOR 22 kV AND 33 kV 50 Hz DISTRIBUTION SYSTEMS WITH ABILITY TO WITHSTAND SHORT CIRCUIT

Specification No. RTRN-035/2561

Approved date : 30/05/2562

Rev. No. : 5

Form No. 02-3S

Page 16 of 32

- (5) Applied voltage test (IEC 60076-1 and IEC60076-3)
- (6) Induced voltage withstand test (IEC 60076-1 and IEC60076-3)

**The Item offered without submitting the list of routine test report shall be rejected.**

#### 1e.2 Type test and Short-circuit withstand test

For transformers rating of 50 kVA to 250 kVA and the reference transformers

For transformers rating of 50 kVA to 250 kVA and the reference transformers, these transformers shall be passed all items of type test and short circuit withstand test according to **1e.2.2 Test procedure of Type test and Short-circuit withstand test**. The test result shall be included in one (1) test report. The test report shall be issued or approved by the same acknowledged independent testing laboratory according to **1e.3 Acknowledged independent testing laboratories**, otherwise will be rejected.

For the others rating which are not the reference transformers

The transformers shall be passed the following type tests in accordance with the relevant standards:

- (1) Temperature-rise test (IEC 60076-2)
- (2) Full wave lightning impulse test (IEC 60076-1 and IEC 60076-3)
- (3) Measurement of no-load loss and current at 90 % and 110 % of rated voltage (IEC 60076-1)

Type test shall be made on only one (1) unit of each rating. The test result shall be included in one (1) test report. The test report shall be issued or approved by the same acknowledged independent testing laboratory according to **1e.3 Acknowledged independent testing laboratories**, otherwise will be rejected.

#### 1e.2.1 Short-circuit withstand test

The transformers shall be designed and constructed to withstand without damage by the thermal and dynamic effects of the external short circuit in accordance with the IEC 60076-5.

The duration of the current  $I$  to be used for the calculation of the thermal ability to withstand short circuit shall be 2 s and the initial temperature for calculation shall be 105°C.

Test procedure of short-circuit withstand test shall be according to **1e.2.2 Test procedure of Type test and Short-circuit withstand test**.

The total number of tests shall be nine made in a different position of the tap-changer according to IEC 60076-5. The duration of each test shall be 0.5 s



การไฟฟ้าส่วนภูมิภาค  
PROVINCIAL ELECTRICITY AUTHORITY

**PROVINCIAL ELECTRICITY AUTHORITY**

**TECHNICAL SPECIFICATION DIVISION**

**THREE-PHASE TRANSFORMERS FOR 22 kV AND 33 kV 50 Hz DISTRIBUTION SYSTEMS  
WITH ABILITY TO WITHSTAND SHORT CIRCUIT**

Specification No. RTRN-035/2561

Approved date : 30/05/2562

Rev. No. : 5

Form No. 02-3S

Page 17 of 32

**1e.2.2 Test procedure of Type test and Short-circuit withstand test**

Each transformer, as delineated by its own unique serial number, is required to pass a complete type test and short-circuit withstand test following the procedures listed below:

- (1) Prior to short circuit testing, each individual transformer must pass the routine test, measurement of no-load loss and current at 90 % and 110 % of rated voltage and temperature-rise tests. Criteria for the temperature-rise test is presented in 1e.8 "Limits of temperature-rise"
- (2) Upon successfully passing the temperature-rise test, each transformer must then successfully pass a short circuit withstand test
- (3) Finally, lightning impulse shall be tested and all the routine tests including measurement of no-load loss and current at 90 % and 110 % of rated voltage shall be repeated. Each transformer shall pass the routine test, measurement of no-load loss and current at 90 % and 110 % of rated voltage and lightning impulse test.

The impulse test sequence is applied to each of line terminal of the tested winding in succession.

The other line terminals of the transformer shall be earthed directly or through an impedance.

If the laboratories intend to use PEA's power system as power supply for the short-circuit withstand testing, the transformer's manufacturer or the laboratories shall submit technical documents of the test such as test procedure, test circuit diagram, test and protection equipment, testing date and calculation of voltage drop in PEA's power system caused by the test to PEA for consideration and approval before the tests are proceeded.

It is responsible of the laboratories to compensate all failure or damage occurred to PEA's power system caused by the test.

PEA reserves the right to send representatives to witness the test.

**The cost of all tests and reports shall be borne by the bidders/manufacturers/contractor.**

**1e.2.3 Type test and short circuit test report**

For 50 to 250 kVA transformers, the bidders have to submit the type test and short circuit test report of the identical transformer (purchased transformer) with the bid, otherwise shall be rejected

For transformers which rated power more than 250 kVA, the bidders have to submit the following document with the bid, otherwise shall be rejected.

- (1) The type test report of the identical transformer (purchased transformer), and
- (2) The short circuit test report of identical transformer (purchased transformer) or the reference transformer according to 1e.2.2 Test procedure of Type test and Short-circuit withstand test, and
- (3) The calculation report<sup>(1)</sup> and others information according to APPENDIX 1.

**Note**

<sup>(1)</sup> In case of the bidders submit the short circuit test report of the reference transformer,



การไฟฟ้านครหลวง  
PROVINCIAL ELECTRICITY AUTHORITY

# PROVINCIAL ELECTRICITY AUTHORITY

## TECHNICAL SPECIFICATION DIVISION

### THREE-PHASE TRANSFORMERS FOR 22 kV AND 33 kV 50 Hz DISTRIBUTION SYSTEMS WITH ABILITY TO WITHSTAND SHORT CIRCUIT

Specification No. RTRN-035/2561

Approved date : 30/05/2562

Rev. No. : 5

Form No. 02-3S

Page 18 of 32

The type test and short-circuit withstand test report of the transformers which are conducted or inspected by Thailand's national laboratories/institutes shall be valid within five (5) years count from the issued date in the test reports to the bid closing date.

For the type test and short-circuit withstand test report of the transformers which are conducted or inspected by laboratories/institutes, with in other countries shall be valid within ten (10) years count from the issued date in the test reports to the bid closing date.

PEA will also accept other documents instead of the type test and short-circuit withstand test reports in the following conditions:

- (1) In case the proposed transformer has been supplied to PEA and get the order from PEA's Procurement Department or Substation Work Department or Transmission and Distribution System Work Department (from PEA's head office), the Purchase Order (PO) or Contract with List of suppliers or Proposal form can be submitted, or
- (2) In case the proposed transformer has been registered for PEA Product Acceptance, the not-expired registration certificate counted to the bid closing date can be submitted, or
- (3) In case the proposed transformer has been registered for Product lists for substation turnkey project, the not-expired registration certificate counted to the bid closing date can be submitted instead

However the document in case (1), (2) and (3) shall be proved that the transformer specified in the PO or Contract with List of suppliers or Proposal form or registration certificate shall be the same product, type/model and all ratings as the proposed transformer for this bid.

**The cost of all tests and reports shall be borne by the bidders/manufacturers/contractor.**

#### 1e.3 Acknowledged independent testing laboratories

The type test and short-circuit withstand test shall be conducted or inspected by the acknowledged testing laboratories/institutes as follows:

- (1) Laboratories/institutes which are members of the Short-circuit Testing Liaison (STL) or independent laboratories/institutes which are accredited according to TIS 17025 or ISO/IEC 17025 with the scope of accreditation covered the relevant test items, standards and equipment. The certification and scope of accreditation of the independent laboratories/institutes shall be submitted with the bid for consideration.

The bidders or manufacturers who are accredited according to TIS 17025 or ISO/IEC 17025 preferring to carry out the type tests and short-circuit withstand test of the transformers with the laboratories or by the manufacturers themselves, the tests shall be inspected by Thailand's



การไฟฟ้านครหลวง  
PROVINCIAL ELECTRICITY AUTHORITY

# PROVINCIAL ELECTRICITY AUTHORITY

## TECHNICAL SPECIFICATION DIVISION

### THREE-PHASE TRANSFORMERS FOR 22 kV AND 33 kV 50 Hz DISTRIBUTION SYSTEMS WITH ABILITY TO WITHSTAND SHORT CIRCUIT

Specification No. RTRN-035/2561

Approved date : 30/05/2562

Rev. No. : 5

Form No. 02-3S

Page 19 of 32

national laboratories, institutes, universities and electric utilities in (2) and other laboratories, institutes, universities or electric utilities approved by PEA.

(2) Thailand's national laboratories, institutes, universities and electric utilities, as follow:

- Electricity Generating Authority of Thailand (EGAT)

(3) Other laboratories, institutes, universities or electric utilities approved by PEA. In this case, the detail of the test facilities of the laboratories shall be submitted to PEA for approval before proceeding the tests and before the bid closing date. PEA reserves the right to send representatives to inspect and witness the tests with the cost of the bidders or manufacturers.

#### 1e.4 The information in the Test report

The minimum information of the transformer in the type test and short-circuit withstand test report shall be the following items:

##### 1. Transformer information

- (1) Manufacturer's name
- (2) Model
- (3) Manufacturer's serial number
- (4) Number of phase
- (5) Rated voltage of the high-voltage winding
- (6) Rated voltage of the low-voltage winding
- (7) Rated voltage ratio
- (8) Rated frequency
- (9) Rated power
- (10) Rated current of the high-voltage winding
- (11) Rated current of the low-voltage winding
- (12) Short-circuit impedance at 75°C
- (13) Connection symbol
- (14) Cooling method
- (15) Total mass
- (16) Mass of core and winding
- (17) Oil quantity
- (18) Highest voltage for equipment applicable the high-voltage winding
- (19) Highest voltage for equipment applicable the low-voltage winding
- (20) Rated insulation level
- (21) Type of construction





**PROVINCIAL ELECTRICITY AUTHORITY**

**TECHNICAL SPECIFICATION DIVISION**

**THREE-PHASE TRANSFORMERS FOR 22 kV AND 33 kV 50 Hz DISTRIBUTION SYSTEMS  
WITH ABILITY TO WITHSTAND SHORT CIRCUIT**

Specification No. ITRN-035/2561

Approved date : 30/05/2562

Rev. No. : 5

Form No. 02-38

Page 20 of 32

- (23) Low-voltage winding type and material.
- (24) Cross-section of the conductor in the high-voltage winding
- (25) Cross-section of the conductor in the low-voltage winding
- (26) Number of strands per turn of high voltage winding
- (27) Number of strands per turn of low voltage winding
- (28) Number of strands radially across the layer (for all turns) of high voltage winding
- (29) Number of strands radially across the layer (for all turns) of low voltage winding
- (30) Total number of turns per phase
- (31) Number of turns each tap

**2. Drawing**

- (1) Overall dimensions of transformer
- (2) Tank dimension
- (3) Drawing of cross section area of core
- (4) Drawing of active part
- (5) Drawing which show the core and coil information according to Figure 7

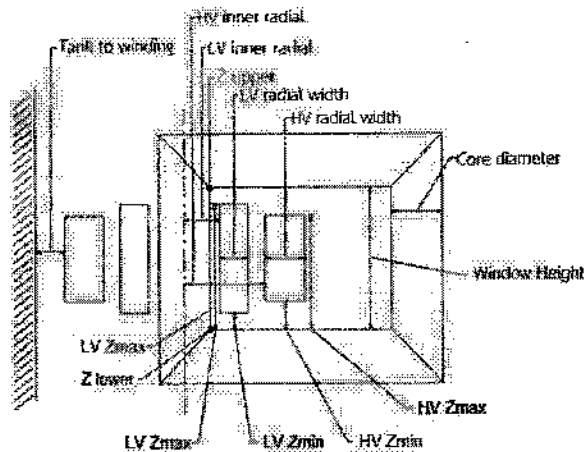

**Figure 7: Core and coil constructions.**

**3. Photograph of transformers**

The color photograph which reveal transformer construction for out-of-tank inspection before and after short-circuit withstand test shall be in the short-circuit withstand test report.

In case the information in the reports are not completed according to the above requirement, the bidders will be rejected.



การไฟฟ้าส่วนภูมิภาค  
PROVINCIAL ELECTRICITY AUTHORITY

# PROVINCIAL ELECTRICITY AUTHORITY

## TECHNICAL SPECIFICATION DIVISION

### THREE-PHASE TRANSFORMERS FOR 22 kV AND 33 kV 50 Hz DISTRIBUTION SYSTEMS WITH ABILITY TO WITHSTAND SHORT CIRCUIT

Specification No. RTRN-035/2561

Approved date : 30/05/2562

Rev. No. : 5

Form No. 02-3S

Page 21 of 32

#### 1e.5 Acceptance test items and acceptance test procedures

##### 1e.5.1 Acceptance test items

The sample of transformers shall pass the following tests in accordance with the IEC 60076 and IEC 60156 standards:

- (1) Measurement of winding resistance (IEC 60076-1)
- (2) Measurement of voltage ratio and check of phase displacement (IEC 60076-1)
- (3) Measurement of short-circuit impedance and load loss (IEC 60076-1)
- (4) Measurement of no-load loss and current (IEC 60076-1)
- (5) Applied voltage test (IEC 60076-1 and IEC60076-3)
- (6) Induced voltage withstand test (IEC 60076-1 and IEC60076-3)
- (7) Oil Dielectric Breakdown voltage test (IEC 60156)
- (8) Temperature-rise test (IEC 60076-2)<sup>(1)</sup>
- (9) Full wave lightning impulse test (IEC 60076-3)<sup>(1)</sup>
- (10) Short-circuit withstand test (IEC 60076-5)<sup>(2)</sup> (only for transformer rating of 50-250 kVA)
- (11) Dry film thickness test, the dry film thickness test procedure shall be according to 1c.12.1

#### Painting system

#### Note

<sup>(1)</sup> The Items (8) and (9) shall be tested on one (1) unit for each contract at the PEA laboratory or Acknowledged independent laboratories approved by PEA as specified in 1e.3 **Acknowledged independent testing laboratories** or manufacturer laboratories depending on PEA's acceptance committee

<sup>(2)</sup> The Items (10) shall be tested on one (1) unit for each contract at Acknowledged Independent laboratories depend on PEA's acceptance committee approved by PEA as specified in 1e.3 **Acknowledged independent testing laboratories.**

Any transformers which are out-of-tank for inspection in short-circuit withstand test, the insulating oil shall be dehydration at manufacture's factory and oil dielectric breakdown voltage shall be retested. The report of oil dielectric breakdown voltage test shall be submitted to PEA before shipment/delivery, for each ordered transformer.

##### 1e.5.2 Acceptance test procedures

PEA's acceptance committee will select the sample of each lot, the number of transformer per lot according to Table 10. All sampling units shall be transported to PEA laboratory or Acknowledged independent laboratories for testing according to 1e.5.1 **Acceptance test items.** The transportation shall be carried out by the contractor.



การไฟฟ้าส่วนภูมิภาค  
PROVINCIAL ELECTRICITY AUTHORITY

# PROVINCIAL ELECTRICITY AUTHORITY

## TECHNICAL SPECIFICATION DIVISION

### THREE-PHASE TRANSFORMERS FOR 22 kV AND 33 kV 50 Hz DISTRIBUTION SYSTEMS WITH ABILITY TO WITHSTAND SHORT CIRCUIT

Specification No. RTRN-035/2561

Approved date : 30/05/2562

Rev. No. : 5

Form No. 02-3S

Page 22 of 32

**Table 10 The number of sample and criteria for consideration**

Number of transformer per lot (Unit)	Sample size of transformers for acceptance test (Unit)	Maximum number of sample failing in the acceptance test (Unit)
2 to 15	2	0
16 to 25	3	0
26 to 90	5	0
91 to 150	8	0
151 to 500	13	1
More than 500	20	1

The number of failing units shall not more than the maximum number of failing sample in the acceptance test according to **Table 10**. Otherwise, the transformers in that lot shall be rejected.

In case the failing units are not more than the maximum number of failing sample in the acceptance test according to **Table 10**, the contractor has to take responsibility as following procedure.

- (1) The contractor has to recheck all delivered transformers in that lot and repair or fix the defective transformers in that lot.
- (2) The contractor shall analyze the problem and send the report to PEA's acceptance committee before the lot accepted.
- (3) The transformers which are repaired or fixed in that lot shall be retested only in the relevant test items according to **1e.5.1 Acceptance test items**.

After the test, the transformers shall be rebuilt completely by the contractor with free of charge and send back to PEA with the same amount of the samples.

#### 1f Inspection

To ensure about the quality of transformers, the inspection shall be carried out by the PEA's representative (PEA's witness committee) at following two stages:

- At anytime during receipt of raw material and manufacture/ assembly whenever the PEA desires.
- At finished stage i.e. transformers are fully assembled and are ready for dispatch.



การไฟฟชาลยพวงศภคภค  
PROVINCIAL ELECTRICITY AUTHORITY

**PROVINCIAL ELECTRICITY AUTHORITY**

**TECHNICAL SPECIFICATION DIVISION**

**THREE-PHASE TRANSFORMERS FOR 22 kV AND 33 kV 50 Hz DISTRIBUTION SYSTEMS  
WITH ABILITY TO WITHSTAND SHORT CIRCUIT**

Specification No. RTRN-035/2561

Approved date : 30/05/2562

Rev. No. : 5

Form No. 02-3S

Page 23 of 32

**C2 Material and packing data to be given by bidders**

The bidders have to submit the following data and details of transformers and accessories with the bid:

**2a Performance data and guarantee of three-phase transformers. (See pages 26 to 30 of 32)**

**2b Drawing of inside tank and overall transformer with dimensions in mm showing of particulars of normal construction details.**

**2c Drawings, with dimensions in mm, of the following accessories:**

1. HV and LV bushings
2. Terminal connectors, on HV and LV bushings, with description of materials used for the component parts
3. Nameplate with connection diagram
4. Valve, showing the internal construction
5. Earthing terminal connector
6. Dehydrating breather, and details of coupling (if any)
7. Bracket for surge arrester
8. Earthing terminal for surge arrester
9. Lifting lug
10. Lifting eye
11. Pressure relief valve
12. Thermometer pocket
13. Oil level gange
14. Oil filling plug
15. Supporting lugs
16. Compression type of cable lug
17. Sludge drain plug
18. Accessories according to manufacturer's design, if any

**2d Catalogues and/or drawings with details of the following accessories:**

1. Dial type thermometer
2. Double float Buchholz relay
3. Pressure-relief valve
4. Bird guard
5. Core
6. HV and LV Winding



การไฟฟ้านครหลวง  
PROVINCIAL ELECTRICITY AUTHORITY

# PROVINCIAL ELECTRICITY AUTHORITY

## TECHNICAL SPECIFICATION DIVISION

### THREE-PHASE TRANSFORMERS FOR 22 kV AND 33 kV 50 Hz DISTRIBUTION SYSTEMS WITH ABILITY TO WITHSTAND SHORT CIRCUIT

Specification No. RTRN-035/2561

Approved date : 30/05/2562

Rev. No. : 5

Form No. 02-3S

Page 24 of 32

8. Insulation paper
  9. Gaskets
  10. Oil drain vale
  11. Accessories according to manufacturer's design, if any
- 2e Dry film thickness test report**
- 2f Type test and Short-circuit withstand test report**
- 2g List of routine test**
- 2h Drawing of core and coil construction**
- 2i Specifications of transformer oil and test report**
- 2j HV and LV Bushing test report**
- 2k Others necessary information in order to show that the special test report can prove the performance of the proposed transformers.**
- 2l Bidders shall propose and quote for recommended spare part list with separate price for each offered item (e.g., bushings)**
- 2m Packing details**
- Packing method (shown by drawing(s), and describe packing materials)
- Number of transformers in one (1) crate or wooden case (one)
- Overall dimensions (L x W x H) of each crate or wooden case in cm
- Volume of each crate or wooden case in m<sup>3</sup>
- Gross weight of each crate or wooden case in kg
- Number of crates or wooden cases
- 2n Critical documents of the transformers (See page 25 of 32)**
- The lists of documents shall be fulfilled and submitted with the bid.







การไฟฟ้าส่วนภูมิภาค  
PROVINCIAL ELECTRICITY AUTHORITY

**PROVINCIAL ELECTRICITY AUTHORITY**

**TECHNICAL SPECIFICATION DIVISION**

**THREE-PHASE TRANSFORMERS FOR 22 kV AND 33 kV 50 Hz DISTRIBUTION SYSTEMS  
WITH ABILITY TO WITHSTAND SHORT CIRCUIT**

Specification No. RTRN-035/2561

Approved date : 30/05/2562

Rev. No. : 5

Form No. 02-3S

Page 26 of 32

**Invitation to Bid No.:**

**2a Performance data and guarantee of three-phase transformers**

Item .....

Manufacturer's name and country of origin		
Type or model		
Applied standard		
Rated power	kVA	
Rated frequency	Hz	
Rated primary voltage	V	
Rated secondary voltage	V	
Connection symbol	Dyn11	
Type of oil preservation system	-	
Operation duty: continuous operation (Type DB)	Yes/No	
Max. temperature rise of winding (at full load)	K	
Max. temperature rise of top oil (at full load)	K	
Primary tapping: off-circuit condition	Yes/No	
Number of steps of primary tapping	Steps	
Per cent of rated voltage of each tapping	%	
No-load current & Tolerance	% & %	&
Short-circuit impedance at 75°C & Tolerance	% & %	&
<u>Losses</u> , for each transformer unit		
No-load loss <u>plus positive tolerance</u>	W	
Load loss, <u>plus positive tolerance</u> , at 75°C	W	
Efficiency in %, at 75°C and at load:		
- 1/2 of rated power and P.F. = 1.0	%	
- 1 of rated power and P.F. = 1.0	%	
Voltage regulation at P.F. = 1.0	%	



การไฟฟ้าส่วนภูมิภาค  
PROVINCIAL ELECTRICITY AUTHORITY

**PROVINCIAL ELECTRICITY AUTHORITY**

**TECHNICAL SPECIFICATION DIVISION**

**THREE-PHASE TRANSFORMERS FOR 22 kV AND 33 kV 50 Hz DISTRIBUTION SYSTEMS  
WITH ABILITY TO WITHSTAND SHORT CIRCUIT**

Specification No. RTRN-035/2561

Approved date : 30/05/2562

Rev. No. : 5

Form No. 02-3S

Page 27 of 32

Item .....

		HV	LV
		<b>Bushings</b>	
- Manufacturer's name	-		
- Country of origin	-		
- Applied standard	-		
- Rated current	A		
- Full-wave impulse withstand voltage, or BIL	kV, peak		
- Low-frequency dry 1-minute test voltage	kV, r.m.s.		
- Low-frequency wet 10-second test voltage	kV, r.m.s.		
- Protection class	-		
- Colour of glazing	-		
- Stud thread size, Metric	-		
Secondary neutral point is loaded with rated current	Yes/No		
<b>Terminal connectors on HV and LV bushings</b>			
- Manufacturer's name	-		
- For copper conductor diameter range (HV side)	mm		
- For aluminium conductor diameter range (HV side)	mm		
- For copper conductor diameter range (LV side)	mm		
- For aluminium conductor diameter range (LV side)	mm		
- Number of circuits, take-off (LV side)	Circuits		
- Terminal pads are according to PEA's Drawing No. SA4-015/47002	Yes/No		
<b>Winding</b>		HV	LV
- Manufacturer's name (the bidders have to quote not more than three (3) manufacturers)	-		
- Country of origin	-		
- Material: copper	Yes/No		
- Type of enamel or insulating material of wire	-		
- Size of wire			
- for HV side (diameter)	mm		
- for LV side (dimension)	mm x mm		
- for LV side (resistance at 75°C)	Ohm		



การไฟฟ้านครหลวง  
PROVINCIAL ELECTRICITY AUTHORITY

**PROVINCIAL ELECTRICITY AUTHORITY**

**TECHNICAL SPECIFICATION DIVISION**

**THREE-PHASE TRANSFORMERS FOR 22 kV AND 33 kV 50 Hz DISTRIBUTION SYSTEMS  
WITH ABILITY TO WITHSTAND SHORT CIRCUIT**

Specification No. RTRN-035/2561

Approved date : 30/05/2562

Rev. No. : 5

Form No. 02-3S

Page 28 of 32

Item .....

- Full-wave impulse withstand voltage, or BIL	kV, peak	
- Power-frequency test voltage, 1 min	kV, r.m.s.	
- Construction of winding	-	
- Current density	A/mm <sup>2</sup>	
- Number of layer per coil	-	
- Number of turns of each coil in tap No.3	Turns	
- Number of turns of each tapping position	Turns	
- Total turns of each coil	Turns	
<b>Core</b>		
- Manufacturer's name (the bidders have to quote not more than three (3) manufacturers)	-	
- Country of origin	-	
<b>Pressure relief valve</b>		
- Manufacturer's name	-	
- Country of origin	-	
- Type or model	-	
- Operating pressure	kg/cm <sup>2</sup>	
- Flow rate at..... kg/cm <sup>2</sup>	cc/sec	
Method of cooling	-	
Total cooling surface	m <sup>2</sup>	
Brand of oil used for initial filling	-	
Completely assembled transformer shall withstand, without permanent deformation, a maximum pressure of	kg/cm <sup>2</sup>	
Colour of tank: grey (RAL 7036)	Yes/No	
Tank finish conforms to PEA's requirement	Yes/No	
Quantity of oil filling	liters	
Mass of core	kg	
Mass of winding	kg	
Mass of the part liftable from tank	kg	
Mass of complete transformer with oil	kg	
Terminal markings and connections conform to PEA's	Yes/No	



การไฟฟ้าส่วนภูมิภาค  
PROVINCIAL ELECTRICITY AUTHORITY

**PROVINCIAL ELECTRICITY AUTHORITY**

**TECHNICAL SPECIFICATION DIVISION**

**THREE-PHASE TRANSFORMERS FOR 22 kV AND 33 kV 50 Hz DISTRIBUTION SYSTEMS**

**WITH ABILITY TO WITHSTAND SHORT CIRCUIT**

Specification No. RTRN-035/2561

Approved date : 30/05/2562

Rev. No. : 5

Form No. 02-3S

Page 29 of 32

Item .....

<p><b>Tank</b></p> <ul style="list-style-type: none"> <li>- Thickness of side wall</li> <li>- Thickness of top plate</li> <li>- Thickness of bottom plate</li> </ul> <p><b>Internal dimensions</b></p> <ul style="list-style-type: none"> <li>- Height</li> <li>- Width</li> <li>- Depth</li> </ul>	<p>mm</p> <p>mm</p> <p>mm</p> <p>mm</p> <p>mm</p> <p>mm</p> <p>mm</p>	
<p><b>Dimensions of transformer</b></p> <ul style="list-style-type: none"> <li>Overall height</li> <li>Overall width</li> <li>Overall depth</li> <li>Height over cover</li> </ul>	<p>mm</p> <p>mm</p> <p>mm</p> <p>mm</p>	
<p><b>Total dry film thickness</b></p>	<p>µm</p>	
<p><b>Fin</b></p> <ul style="list-style-type: none"> <li>- Fin radiators or Corrugated thickness</li> <li>- Dimension of each fin (LxBxT)</li> </ul> <p><b>Number of Fins per radiator</b></p> <ul style="list-style-type: none"> <li>- Side of tank</li> <li>- Front of tank</li> <li>- Total number of fin</li> </ul>	<p>mm</p> <p>mm</p> <p>-</p> <p>-</p> <p>-</p>	
<p><b>Bushing clearance</b></p> <p>Please fill in the shortest of clearance</p> <ul style="list-style-type: none"> <li>LV to earth</li> <li>HV to earth</li> <li>Between LV bushing</li> <li>Between HV bushing</li> </ul>	<p>mm</p> <p>mm</p> <p>mm</p> <p>mm</p> <p>mm</p>	
<p>Detail documents of Item 1 on Page 31 to 32 of 32 shall be sent to PEA before shipment/delivery</p>	<p>Yes/No</p>	



การไฟฟชาภชาชน  
PROVINCIAL ELECTRICITY AUTHORITY

**PROVINCIAL ELECTRICITY AUTHORITY**

**TECHNICAL SPECIFICATION DIVISION**

**THREE-PHASE TRANSFORMERS FOR 22 kV AND 33 kV 50 Hz DISTRIBUTION SYSTEMS  
WITH ABILITY TO WITHSTAND SHORT CIRCUIT**

Specification No. RTRN-035/2561

Approved date : 30/05/2562

Rev. No. : 5

Form No. 02-3S

Page 30 of 32

Item .....

X/R ratio	-	
<b>Rated short circuit current and withstanding duration</b>		
- Current	kA	
- Duration	s	
<b>Duration of overload</b>		
- 25% overload	Minutes	
- 50% overload	Minutes	
Magnetic flux density	Tesla	
<b>Other :</b>		





การไฟฟชาภชาชน  
PROVINCIAL ELECTRICITY AUTHORITY

**PROVINCIAL ELECTRICITY AUTHORITY**

**TECHNICAL SPECIFICATION DIVISION**

**THREE-PHASE TRANSFORMERS FOR 22 kV AND 33 kV 50 Hz DISTRIBUTION SYSTEMS  
WITH ABILITY TO WITHSTAND SHORT CIRCUIT**

Specification No. RTRN-035/2561

Approved date : 30/05/2562

Rev. No. : 5

Form No. 02-3S

Page 31 of 32

**Note: Conditions for documentation and consideration**

1. The Contractor has to supply the following documents in English and/or Thai, before shipment/delivery, for each ordered transformer:

1.1 Report of routine tests

1.2 Number of turns of each winding, each coil, and each tapping position

1.3 Mass of HV windings and of LV windings

1.4 Type of enamel, temperature class, and size of the enameled wire

1.5 Information for Reference (only one(1) unit per contract). The following information for each transformer shall be submitted for maintenance purpose.

- Coil height for each winding before assembly and after complete assembly.
- Torque value on clamping bolts or pressure for each winding before assembly and after complete assembly.
- Photograph of each coil for each phase and photograph of core and coils assembly. The photograph of each coil shall be taken from the final production process before placing to the core, top view and front view shall be provided. The photograph of core and coils assembly shall be taken just prior to place the completed core and coils assembly into the tank, top view, front view, right view, left view and rear view shall be provided for complete set of photographs. All photographs shall be 216 mm (8-1/2 in) by 280 mm (11 in) gloss prints properly labeled relevant to the view taken.

1.6 Invoice and Test report of the following material and accessories used in each supply shall be submitted.

- Transformer oil
- Silicon steel
- Copper conductor
- Insulation paper and pressboard
- Pressure relief
- Gaskets
- Bushing
- Transformer supervisory equipment



การไฟฟ้านครหลวง  
PROVINCIAL ELECTRICITY AUTHORITY

# PROVINCIAL ELECTRICITY AUTHORITY

## TECHNICAL SPECIFICATION DIVISION

### THREE-PHASE TRANSFORMERS FOR 22 kV AND 33 kV 50 Hz DISTRIBUTION SYSTEMS WITH ABILITY TO WITHSTAND SHORT CIRCUIT

Specification No. RTRN-035/2561

Approved date : 30/05/2562

Rev. No. : 5

Form No. 02-3S

Page 32 of 32

The above documents shall be sent to the following address:

Transformer Division  
Provincial Electricity Authority  
200 Ngam Wong Wan Road, Chatuchak  
Bangkok Metropolis 10900  
Thailand

2. If the material and packing data given by bidders, which are mentioned on Pages 23 to 24 of 32 are estimated or approximated, the bid may be rejected.
3. Delivery time is also one of the important factors to be considered.
4. Partial shipment/delivery is allowed.



กรมการไฟฟ้าส่วนภูมิภาค  
PROVINCIAL ELECTRICITY AUTHORITY

## PROVINCIAL ELECTRICITY AUTHORITY

### TECHNICAL SPECIFICATION DIVISION

#### THREE-PHASE TRANSFORMERS FOR 22 kV AND 33 kV 50 Hz DISTRIBUTION SYSTEMS WITH ABILITY TO WITHSTAND SHORT CIRCUIT

Specification No. RTRN-035/2561

Approved date : 04 NOV 2020

Rev. No. : 6

Form No. 02-3S

Page 1 of 3

#### APPENDIX 1

##### Comparison Method

In case the ability to withstand the dynamic short circuit is demonstrated by comparison between the reference transformer and similar transformer. In this case the bidders have to submit the short circuit test report of the reference transformer, calculation report of short circuit force which using Finite Element Method (FEM) software, all necessary information according to Table 3 Design data of the reference transformers and the proposed transformers as well as the necessary information in order to show that the short-circuit withstand test report can prove the performance of the proposed transformers with the bid.

The short circuit test procedure of the reference transformer shall be according to 1e.2.2 Test procedure of Type test and Short-circuit withstand test.

For the ability to withstand the dynamic effects of short circuit test, the total number of tests shall be three made in a different position of the tap-changer according to IEC 60076-5. The duration of each test shall be 0.5 s

The transformer is considered similar or representative to another transformer (proposed transformers) taken as a reference if it has the following characteristics in common with the latter:

- (1) Same type of operation, for example generator step-up unit, distribution, interconnection transformer and same rated voltage according to Table 1;
- (2) Same conceptual design, for example dry-type, oil-immersed type, core type with concentric windings, sandwich type, shell type, circular coils, non-circular coils;
- (3) Same arrangement and geometrical sequence of the main windings;
- (4) Same type of winding conductors, for example aluminium, aluminium alloy, annealed or hardened copper, metal foil wire, flat conductor, continuously transposed conductors and epoxy bonding, if used;
- (5) Same type of main windings for example, helical-, disc-, layer-type, pancake coils;
- (6) Absorbed power at short circuit (rated power/per unit short-circuit impedance) between 30% and 130% of that relating to the reference unit, see Table 2;
- (7) Axial forces, radial forces, axial winding stresses and radial winding stresses occurring at short circuit not exceeding 120% of those in the reference unit. (Force shall be calculated by Finite element program such as FLD12 etc., Hand calculation shall be rejected)
- (8) Same manufacturing processes;
- (9) Same clamping and winding support arrangement.

In case the comparison method, the short-circuit withstand test report of the reference transformer and a calculation report as a result of the comparison between the reference transformer and proposed



กรมการไฟฟ้าส่วนภูมิภาค  
Regional Electricity Authority

**PROVINCIAL ELECTRICITY AUTHORITY**

**TECHNICAL SPECIFICATION DIVISION**

**THREE-PHASE TRANSFORMERS FOR 22 kV AND 33 kV 50 Hz DISTRIBUTION SYSTEMS  
WITH ABILITY TO WITHSTAND SHORT CIRCUIT**

Specification No. RTRN-035/2561

Approved date: 04 NOV 2020

Rev. No. : 6

Form No. 02-3S

Page 2 of 3

**Table 1**

Type of operation and rated voltage of the proposed transformers similar to the reference transformers

Type and Rated voltage	The reference transformer	The proposed transformers
Type	3 Phase only	3 Phase
Rated primary voltage	22 kV	22 kV
Rated primary voltage	33 kV	33 kV
Rated secondary voltage (3 phase)	416/240 V	416/240 V

**Table 2**

Rated power of the proposed transformers similar to the reference transformers

	Rated power (kVA) of the reference transformers	Rated power (kVA) of the proposed transformers									
		315	400	500 <sup>(1)</sup>	630	800	1,000	1,250	1,500	2,000	
1	250	315		500 <sup>(1)</sup>							
2	315	315	400	500 <sup>(1)</sup>							
3	400	315	400	500 <sup>(1)</sup>	630						
4	500 <sup>(1)</sup>	315	400	500 <sup>(1)</sup>							
5	630	315	400	500 <sup>(1)</sup>	630	800					
6	800	315	400	500 <sup>(1)</sup>	630	800	1,000				
7	1,000	315	400	500 <sup>(1)</sup>	630	800	1,000	1,250			
8	1,250	315	400	500 <sup>(1)</sup>	630	800	1,000	1,250	1,500		
9	1,500	315	400	500 <sup>(1)</sup>	630	800	1,000	1,250	1,500		
10	2,000		400		630	800	1,000	1,250	1,500	2,000	

Note :

<sup>(1)</sup> Based on 6.5% short-circuit impedance. In case the impedance of 500 kVA transformer more than 6.5%, the bidders shall recalculate this table for PEA approval.



မြန်မာနိုင်ငံတော်  
ပတ်ဝန်းကျင်ထိန်းသိမ်းရေး ဝန်ကြီးဌာန

**PROVINCIAL ELECTRICITY AUTHORITY**

**TECHNICAL SPECIFICATION DIVISION**

**THREE-PHASE TRANSFORMERS FOR 22 kV AND 33 kV 50 Hz DISTRIBUTION SYSTEMS  
WITH ABILITY TO WITHSTAND SHORT CIRCUIT**

Specification No. RTRN-035/2561    Approved date: **04 NOV 2020**    Rev. No. : 6    Form No. 02-3S    Page 3 of 3

**Table 3**

**Design data of the reference transformers and the proposed transformers**

Description	Design value of the reference transformers		Design value of the proposed transformers	
Rating (kVA)				
% Short circuit impedance				
Construction of Core				
HV Windings, made of				
LV Windings, made of				
Construction of HV Windings (Layer or disk)				
Construction of LV Windings (Layer or Foil)				
HV Current density (please enclosed the calculation sheet)				
LV Current density (please enclosed the calculation sheet)				
Axial force (please enclosed software calculation sheet)	<u>HV</u>	<u>LV</u>	<u>HV</u>	<u>LV</u>
Axial stress (please enclosed software calculation sheet)	<u>HV</u>	<u>LV</u>	<u>HV</u>	<u>LV</u>
Radial force (please enclosed software calculation sheet)	<u>HV</u>	<u>LV</u>	<u>HV</u>	<u>LV</u>
Radial stress (please enclosed software calculation sheet)	<u>HV</u>	<u>LV</u>	<u>HV</u>	<u>LV</u>
Same arrangement of main windings and geometrical sequence as the reference unit (Yes/No) (please enclosed the winding detail drawing)				
Same clamping and supporting arrangement. (Yes/No) (please enclosed the clamping detail drawing)				

**EME**



**PROVINCIAL ELECTRICITY AUTHORITY  
ELECTRICAL AND MECHANICAL ENGINEERING DIVISION**

Specification No.: RTRN-035/2561

Page 1 of 2

**THREE-PHASE TRANSFORMERS FOR 22 kV AND 33 kV 50 Hz DISTRIBUTION  
SYSTEMS WITH ABILITY TO WITHSTAND SHORT CIRCUIT**

C3 Schedule of detailed requirement

Invitation to Bid No.: ๑.3 ๑๒๒๒.(๑๗.)EBD019-2566

Item	PEA Material No.	Quantity	Description
2	1050010066	61 set(s)	50 kVA, three-phase transformer, permanently sealed and completely oil filled system (without gas cushion) type, withstand short-circuit, 22,000-416/240V, symbol Dyn11
3	1050010067	32 set(s)	100 kVA, three-phase transformer, permanently sealed and completely oil filled system (without gas cushion) type, withstand short-circuit, 22,000-416/240V, symbol Dyn11
4	1050010068	18 set(s)	160 kVA, three-phase transformer, permanently sealed and completely oil filled system (without gas cushion) type, withstand short-circuit, 22,000-416/240V, symbol Dyn11
5	1050010069	16 set(s)	250 kVA, three-phase transformer, permanently sealed and completely oil filled system (without gas cushion) type, withstand short-circuit, 22,000-416/240V, symbol Dyn11
6	1050010070	3 set(s)	315 kVA, three-phase transformer, permanently sealed and completely oil filled system (without gas cushion) type, withstand short-circuit, 22,000-416/240V, symbol Dyn11
7	1050010071	3 set(s)	400 kVA, three-phase transformer, permanently sealed and completely oil filled system (without gas cushion) type, withstand short-circuit, 22,000-416/240V, symbol Dyn11
8	1050010072	4 set(s)	500 kVA, three-phase transformer, permanently sealed and completely oil filled system (without gas cushion) type, withstand short-circuit, 22,000-416/240V, symbol Dyn11
			Note: Enclosed Drawing No.SA4-015/47002 and No.SA.4-015/50008



การไฟฟ้าส่วนภูมิภาค  
PROVINCIAL ELECTRICITY AUTHORITY

**PROVINCIAL ELECTRICITY AUTHORITY  
ELECTRICAL AND MECHANICAL ENGINEERING DIVISION**

Specification No.: RTRN-035/2561

Page 2 of 2

**THREE-PHASE TRANSFORMERS FOR 22 kV AND 33 kV 50 Hz DISTRIBUTION SYSTEMS WITH ABILITY TO WITHSTAND SHORT CIRCUIT**

C3 Schedule of detailed requirement

Invitation to Bid No.: ๓.3 ๓๖๖ (๑๗.)EBD019-2566

Item	PEA Material No.	Quantity	Description
			<p>1. การไฟฟ้าส่วนภูมิภาคจะพิจารณาจัดซื้อ/จัดจ้างผลิตที่ผลิตในประเทศไทย ทั้งนี้ หากผู้เสนอราคาผลิตที่ผลิตในประเทศไทย มีรายละเอียดคุณสมบัติเฉพาะ ไม่เป็นไปตามข้อกำหนดของการไฟฟ้าส่วนภูมิภาค หรือ ไม่มีผู้เสนอผลิตที่ผลิตในประเทศไทย การไฟฟ้าส่วนภูมิภาคจะพิจารณาจัดซื้อ/จัดจ้างผลิตที่ผลิตจากต่างประเทศต่อไป</p> <p>ผลิตที่ผลิตในประเทศไทย หมายความว่า ผลิตกันชนที่ผลิตสำเร็จรูปแล้ว โดยสถานที่ผลิตตั้งอยู่ในประเทศไทย</p> <p>2. ผลิตกันชนที่เสนอจะต้องผลิตจากโรงงานที่ได้รับการรับรองระบบคุณภาพของกระบวนการผลิตตามมาตรฐาน ISO9001 (ตามรายละเอียดคุณสมบัติพิเศษเพิ่มเติม)</p> <p>3. หนังสือแต่งตั้งตัวแทนจำหน่ายกรณีที่เป็นตัวแทนจำหน่ายของผู้ผลิต</p> <p>4. ผลิตกันชนที่เสนอจะต้องเป็นผลิตกันชนที่ได้รับใบอนุญาตแสดงเครื่องหมายมาตรฐานผลิตกันชนอุตสาหกรรม (มอก.) เท่านั้น (ตามรายละเอียดคุณสมบัติพิเศษเพิ่มเติม)</p> <p>5. ผลิตกันชนที่เสนอต้องเป็นผลิตกันชนที่ผลิตจากโรงงานที่ได้รับการรับรองความสามารถห้องปฏิบัติการทดสอบมาตรฐาน มอก. 17025 หรือ ISO/IEC 17025 ครอบคลุมทุกหัวข้อการทดสอบประจำตามที่สเปค กฟภ. กำหนด</p> <p>6. บริษัทผู้ผลิตที่ได้รับการสั่งซื้อ หม้อแปลง ไฟฟ้าต้องระบุน้ำหนักสุทธิ (Net Weight) ของหม้อแปลง ลงบนหม้อแปลงแต่ละเครื่องบน Name Plate</p> <p>7. คู่สัญญาจะต้องเป็นผู้รับผิดชอบค่าใช้จ่ายทั้งหมดในการทดสอบเพื่อการตรวจรับ (Acceptance Test)</p> <p>8. การทดสอบเพื่อประกอบการตรวจรับหม้อแปลงไฟฟ้าในระบบจำหน่าย ณ โรงงานผู้ผลิต ส.1 ให้คณะกรรมการตรวจรับสามารถพิจารณาตรวจรับหม้อแปลงไฟฟ้า ณ โรงงานผู้ผลิตเพื่อเป็นทางเลือกนอกเหนือจากการส่งทดสอบที่กองหม้อแปลง โดยให้คณะกรรมการตรวจรับร่วมกับ คณะกรรมการตรวจสอบการผลิตและทดสอบ (สำน.) และกองหม้อแปลง คู่หม้ออย่างและร่วมทำการทดสอบเพื่อการตรวจรับ ณ โรงงานผู้ผลิต โดยวิธีการทดสอบจะต้องเป็นไปตามมาตรฐาน และวิธีปฏิบัติของการไฟฟ้าส่วนภูมิภาค โดยให้คู่สัญญา เป็นผู้รับผิดชอบค่าใช้จ่ายในการทดสอบทั้งหมด 8.2 ในกรณีที่หม้อแปลงไฟฟ้าสำหรับผู้บริโภค ไฟฟ้าเฉพาะ รายที่จัดซื้อโดยผู้ใช้ไฟฟ้า และหม้อแปลง ไฟฟ้าที่จะต้องจัดส่งให้ การไฟฟ้าส่วนภูมิภาค ทดสอบค่าความเสียหาย (Losses) ก่อนติดตั้ง ใช้งาน ให้ผู้ใช้ไฟฟ้าที่มีความประสงค์ที่จะทำการทดสอบดังกล่าว ณ โรงงานผู้ผลิต แจ้งให้การไฟฟ้าส่วนภูมิภาค จัดส่งผู้แทนเข้าร่วมทดสอบ ณ โรงงานผู้ผลิตก่อนการส่งของ โดยให้ ผู้แทนการไฟฟ้าส่วนภูมิภาค ที่เข้าร่วมทำการทดสอบดังกล่าวพิจารณาทำเครื่องหมายที่หม้อแปลง ไฟฟ้าสำหรับผู้บริโภค ตรวจสอบภายหลังจากการส่งหม้อแปลง ไฟฟ้าดังกล่าวไปที่หน้างาน โดยให้ ผู้ใช้ไฟฟ้าเป็นผู้รับผิดชอบค่าใช้จ่ายในการทดสอบทั้งหมด</p>



Only for 50-500 kVA transformers

PRELIMINARY

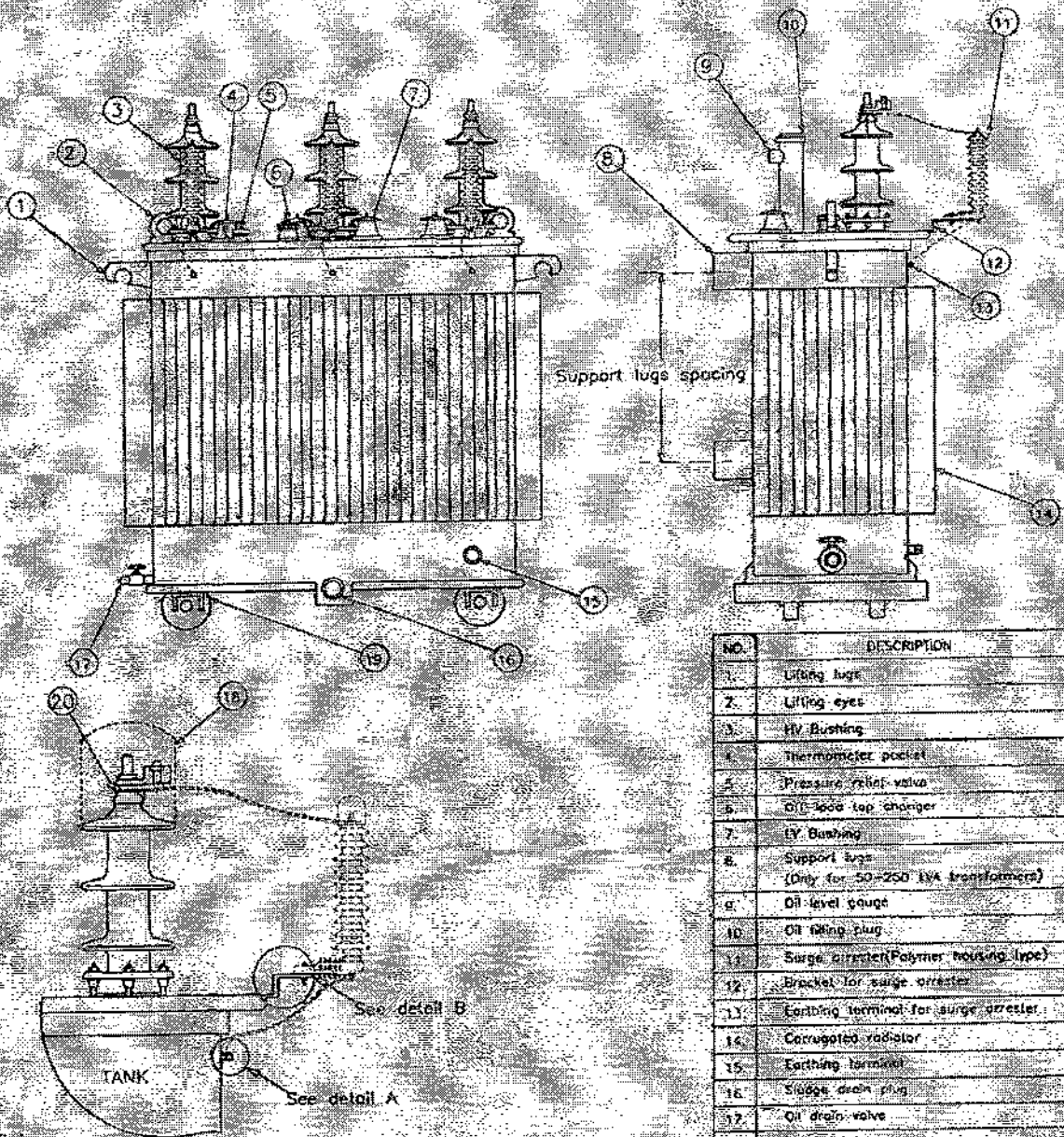

NO.	DESCRIPTION
1.	Lifting lugs
2.	Lifting eyes
3.	HV Bushing
4.	Thermometer pocket
5.	Pressure relief valve
6.	Oil-3000 tap changer
7.	LV Bushing
8.	Support lugs (Only for 50-250 kVA transformers)
9.	Oil level gauge
10.	Oil filling plug
11.	Surge arrester (Polymer housing type)
12.	Bracket for surge arrester
13.	Earthing terminal for surge arrester
14.	Corrugated radiator
15.	Earthing terminal
16.	Sediment drain plug
17.	Oil drain valve
18.	Bird-guard cap
19.	Transport rollers (Only for 315-500 kVA transformers)
20.	Cable lug

- Note :
1. Surge arrester, line lead and ground lead, supplied by PEA
  2. Earthing terminal for surge arrester shall be eye-bolt type or socket type.
  3. Position of earthing terminal for surge arrester shall be suitable for flexible copper insulated ground lead size 16 sq.mm, 430 mm long.
  4. Not to scale

กองมาตรฐานระบบไฟฟ้า ฝ่ายมาตรฐานและควบคุมผลิตภัณฑ์	การไฟฟ้าส่วนภูมิภาค	ใช้แทนแบบ.....
ผู้เขียน.....	ส่วนประกอบขหมอบแปลงไฟฟ้า 3 เฟส	ศึกษาแบบเดิมแบบ.....
ผู้ตรวจ.....		เขียนเสร็จวันที่ 8 มิ.ย. 2552
หัวหน้าแผนก.....		แก้ไขแบบวันที่ 25 พ.ค. 2554
ผู้อำนวยการกอง.....	DETAIL OF 3 PHASE TRANSFORMER	มีดีเป็น.....
		มาตรฐานฉบับ.....
		แบบเลขที่ SAA-015/50008
		ฉบับที่ 1 ของจำนวน 4 ฉบับ

Only for 630-2,000 kVA transformers

PRELIMINARY

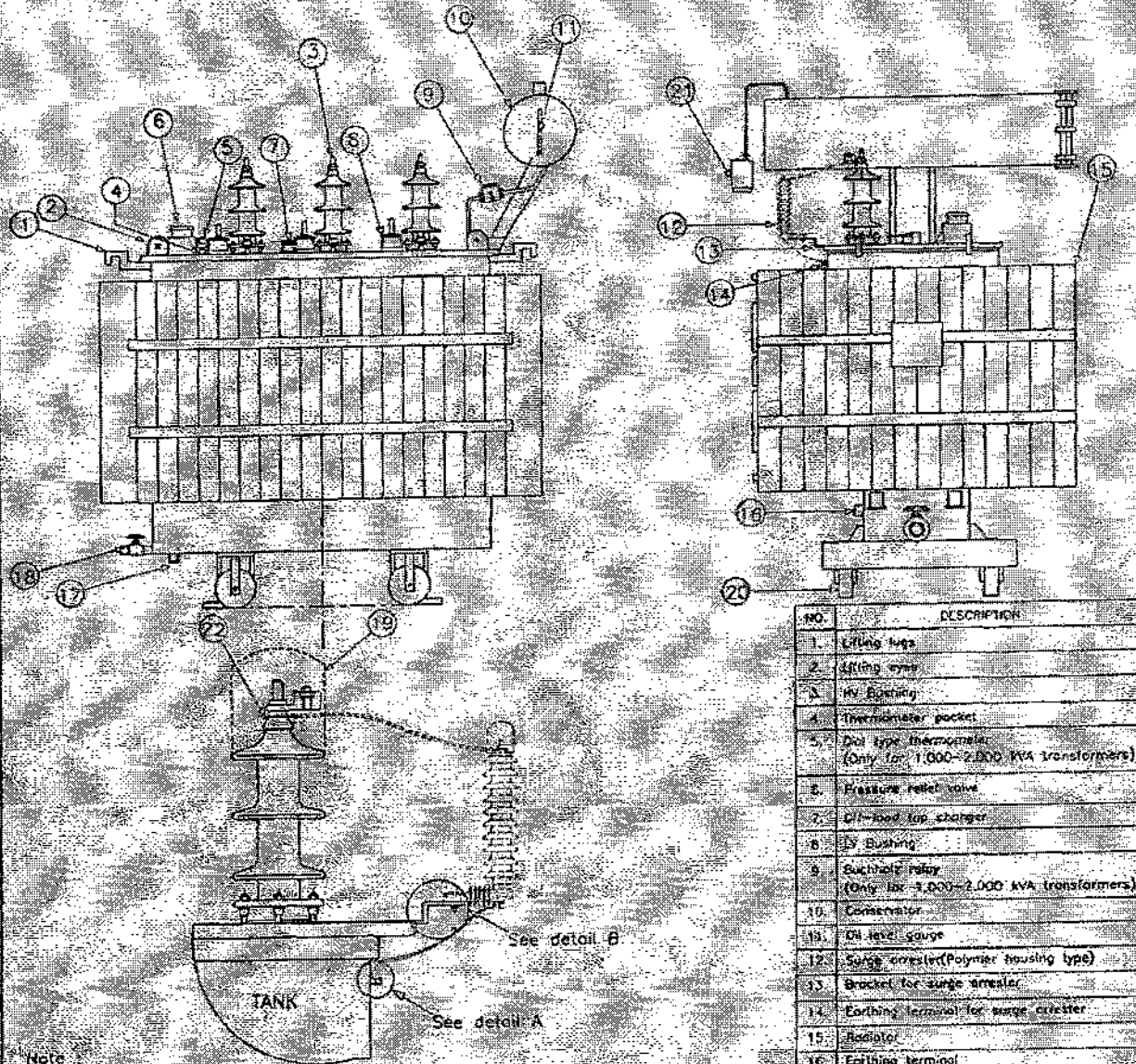

NO.	DESCRIPTION
1	Lifting legs
2	Lifting eyes
3	HV Bushing
4	Thermometer pocket
5	Dial type thermometer (Only for 1,000-2,000 kVA transformers)
6	Pressure relief valve
7	Oil-food tap changer
8	LV Bushing
9	Buchholz Relay (Only for 1,000-2,000 kVA transformers)
10	Conservator
11	Oil level gauge
12	Surge arrester (Polymer housing type)
13	Bracket for surge arrester
14	Earthing terminal for surge arrester
15	Radiator
16	Earthing terminal
17	Sludge drain plug
18	Oil drain valve
19	Bird guard cap
20	Transport rollers
21	Dehydrating breather
22	Cable lug

Note

- Surge arrester, line lead and ground lead supplied by PEA
- Earthing terminal for surge arrester shall be eye-bolt type or socket type.
- Position of earthing terminal for surge arrester shall be suitable for flexible copper insulated ground lead size 16 sqmm, 430 mm long.
- Only for 1,000-2,000 kVA transformers shall be furnished and equipped with
  - Dial type thermometer with adjustable contact(s)
  - Double float Buchholz relay having two (2) contacts (for alarm and tripping)
- Not to scale

โครงการระบบไฟฟ้า  
ตามโครงการและค่าประมูล

การไฟฟ้าส่วนภูมิภาค

โครงการแบบ.....  
ลูกแทนโดยแบบ.....

ผู้เขียน: น.ส. นิติต เพ็ญ  
ผู้สำรวจ: .....  
วิศวกร: .....  
หัวหน้าแผนก: .....  
ผู้อำนวยการกอง: .....

ส่วนประกอบหม้อแปลงไฟฟ้า 3 เฟส

เขียนเสร็จวันที่ 8 มี.ค. 2552  
พิมพ์วันที่ 28 พ.ค. 2554  
มีดเป็น นิติต เพ็ญ  
มาตรฐาน.....  
แบบเลขที่ SA 015/50008  
หน้าที่ 2 ของจำนวน 5 หน้า

DETAIL OF 3 PHASE TRANSFORMER



PRELIMINARY

Detail A

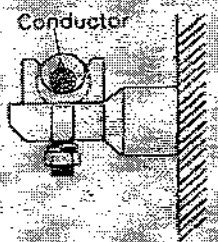
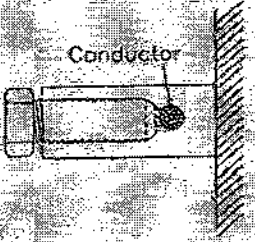
Type of earthing terminal for surge arrester	
 <p style="text-align: center;">eye-bolt type earthing terminal</p>	 <p style="text-align: center;">socket type earthing terminal</p>
<p><u>Description</u></p> <p>Eye-bolt type earthing terminal shall be with eye-bolt type connector suitable for flexible copper insulated ground lead size 16 sq.mm complete with lock washer of stainless steel or better</p>	<p><u>Description</u></p> <p>Socket type earthing terminal shall be with socket suitable for flexible copper insulated ground lead size 16 sq.mm complete with bolt of stainless steel or better for lock conductor</p>

<p>กองมาตรฐานระบบไฟฟ้า กรมการช่างและเครื่องมือกล</p>	<p style="font-size: 1.2em;">การไฟฟ้าส่วนภูมิภาค</p>	<p>ใช้แทนแบบ.....</p> <p>ถูกแทนโดยแบบ.....</p> <p>เขียนเสร็จวันที่ 8 มี.ย. 2552</p> <p>แก้ไขครั้งที่ 26 พ.ค. 2554</p> <p>ชนิดสาร..... มิถิลีเมตริก</p> <p>มาตราส่วน.....</p> <p>แบบเลขที่ SA4-015/S0098</p> <p>แผ่นที่ 3 ของจำนวน 4 แผ่น</p>
<p>ผู้เขียน..... บ.พิศ เพ็ชต์</p> <p>ผู้สำรวจ.....</p> <p>ผู้ตรวจ.....</p> <p>หัวหน้าแผนก.....</p> <p>ผู้อำนวยการกอง.....</p>	<p style="font-size: 1.2em;">ส่วนประกอบหม้อแปลงไฟฟ้า 3 เฟส</p> <p style="font-size: 1.2em;">DETAIL OF 3 PHASE TRANSFORMER</p>	

PRELIMINARY

Detail B :

Detail of mounting bracket for surge arrester

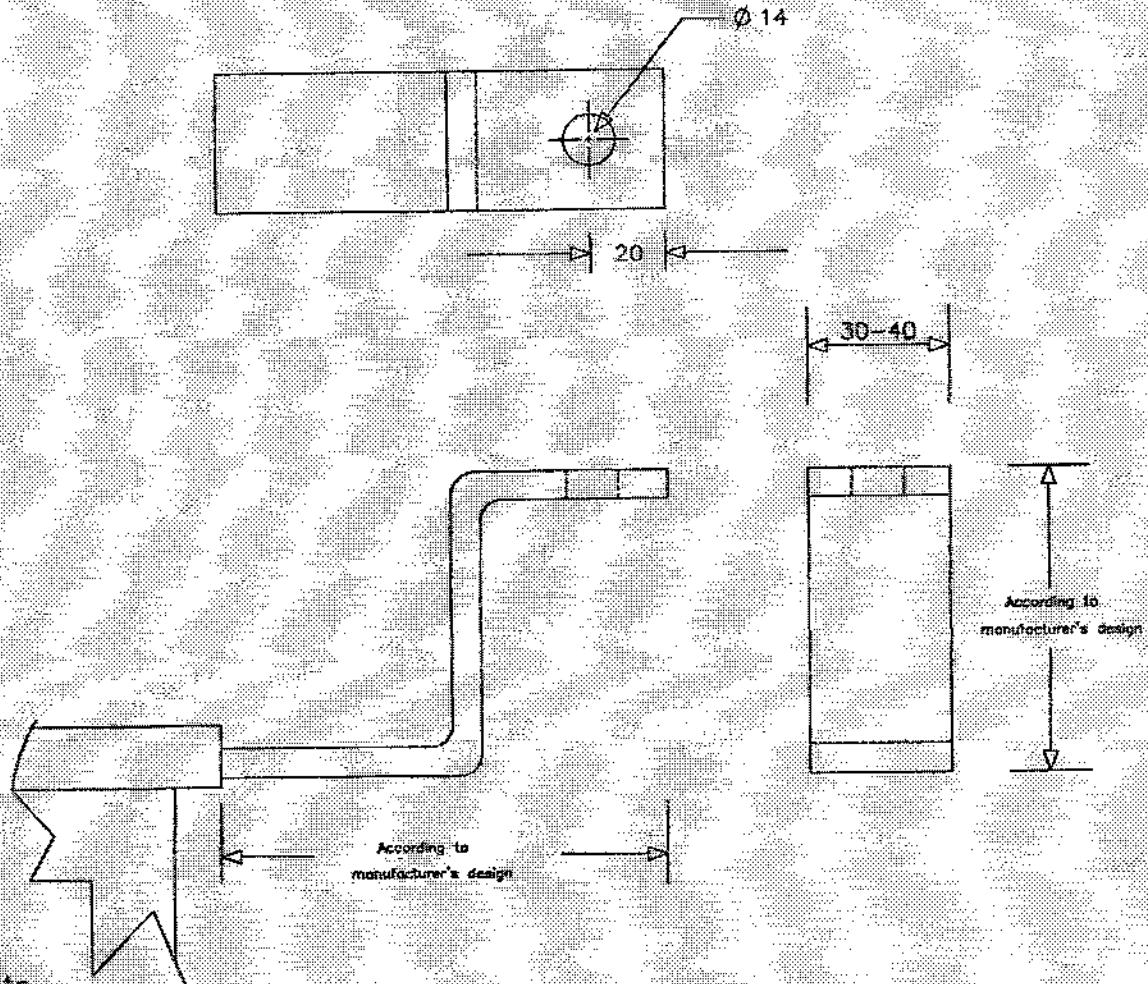

Note.

1. Material of mounting bracket shall be stainless steel or painted with RAL gray color. And paint system shall be system No. A.3.08, according to table A.3 ISO12944-5 which the total thickness not less than 160 um.
2. Shape and dimension of mounting bracket, unless specified shall be according to manufacturer's design.
3. The mounting bracket shall be designed to support up to 8 kg surge arrester.

<p>กองข้อกำหนดทางเทคนิค ฝ่ายวิศวกรรม</p>	<p>การไฟฟ้าส่วนภูมิภาค</p>	<p>ใช้แทนแบบ..... ถูกแทนโดยแบบ.....</p>
<p>ผู้เขียนมาตรฐาน เติมแพงพันธ์ ผู้สำรวจ..... วิศวกร..... หัวหน้าแผนก..... ผู้อำนวยการกอง.....</p>	<p>ส่วนประกอบหม้อแปลง 3 เฟส สำหรับจ้างซ่อม</p>	<p>เขียนเสร็จวันที่ 26 พ.ค. 2554 แก้แบบวันที่ 21 พ.ย. 2561 มีดเป็น นิลลิเมตร</p>
	<p>DETAIL OF SURGE ARRESTER TRANSFORMER</p>	<p>มาตราส่วน..... แบบเลขที่ SA4-015/50008</p>



การประกอบและที่  
ASSEMBLY NO.

**PRELIMINARY**

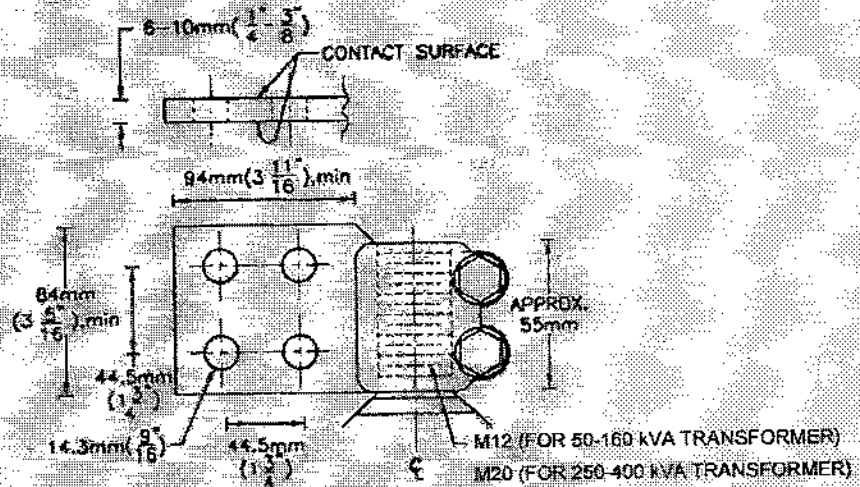

FIGURE 1

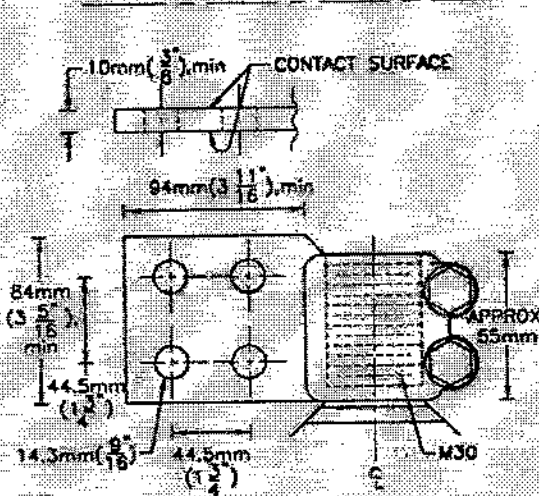

FIGURE 2

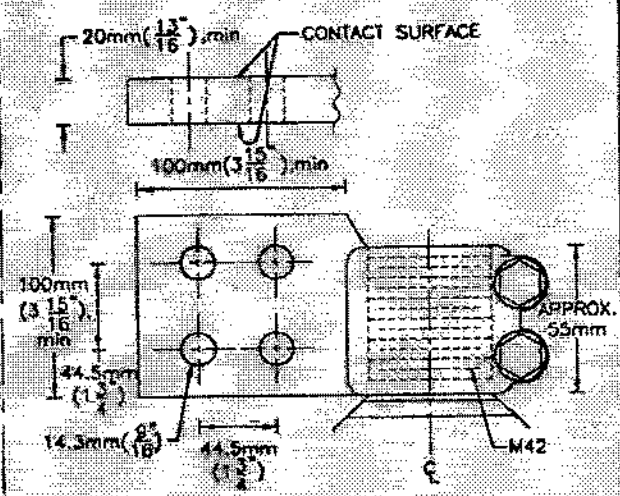

FIGURE 3

NOTES :

1. FIGURE 1 FOR 50-160 kVA TRANSFORMER
2. FIGURE 1 FOR 250-400 kVA TRANSFORMER
3. FIGURE 2 FOR 500-530 kVA TRANSFORMER
4. FIGURE 3 FOR 800-1,250 kVA TRANSFORMER

<p>กองมาตรฐานระบบไฟฟ้า ฝ่ายมาตรฐานและความปลอดภัย</p>	<p><b>การไฟฟ้าส่วนภูมิภาค</b></p>	<p>SA2-015/28006 ใช้แบบแบบ SA2-015/29013 SA4-015/45002</p>
<p>เขียน <i>Suphahit Anonngy</i> ผู้สำรวจ วิศวกร หัวหน้าแผนก ผู้อำนวยการกอง ผู้อำนวยการฝ่าย</p>	<p>ผู้ว่าการ  รายละเอียดของชุดต่อสายแรงต่ำสำหรับ หม้อแปลงไฟฟ้า สามเฟส 50-1,250 kVA</p>	<p>เขียนเสร็จวันที่ 19. พ.ย. 2547 หน้าแผ่นที่ มีดเป็น มีสติเมตร มาตรฐาน</p>
<p>รองผู้อำนวยการแผนก และหัวหน้างานไฟฟ้า</p>	<p>DETAIL OF L.V. TERMINAL PADS FOR 50-1,250 kVA THREE-PHASE TRANSFORMER</p>	<p>แบบเลขที่ SA4-015/47602</p>

# PRELIMINARY

การประกอบและติดตั้ง (จ.ร.) EBD019-2566  
ASSEMBLY NO.

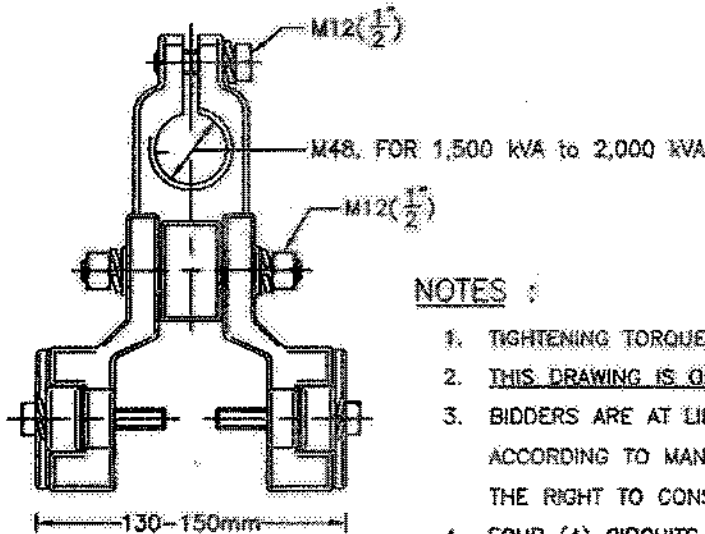
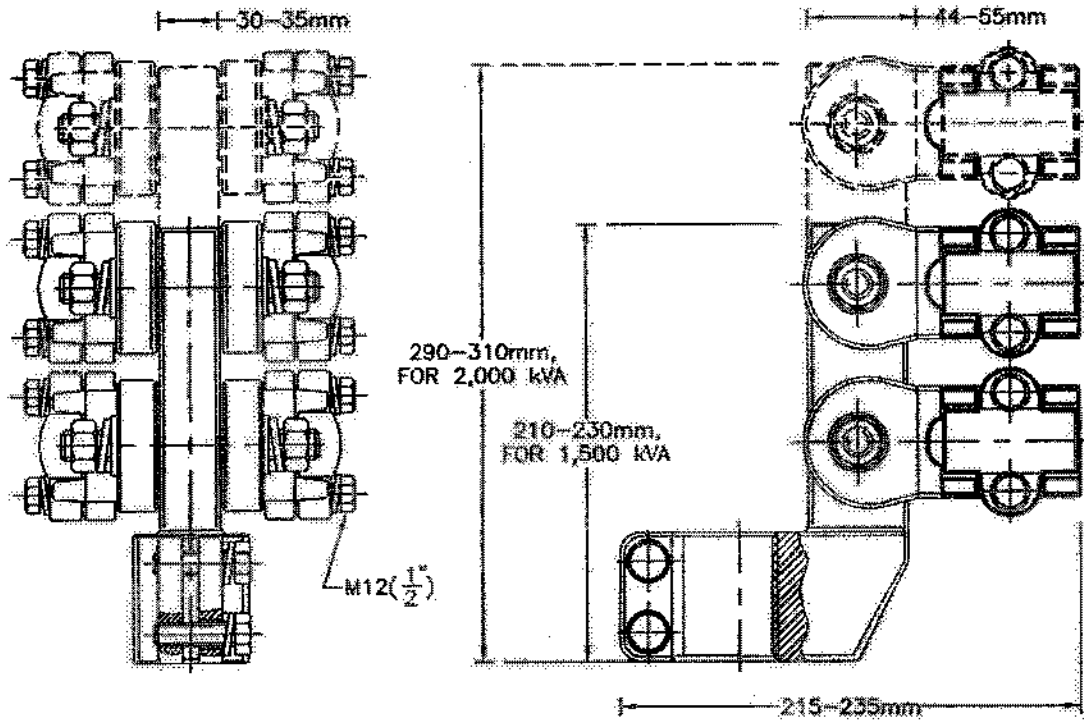

## NOTES :

1. TIGHTENING TORQUE LEVEL OF BOLTS M12( $\frac{1}{2}$ ) : 5.5 kgf-m
2. THIS DRAWING IS ONLY GUIDING (NOT COMPELLING).
3. BIDDERS ARE AT LIBERTY TO QUOTE THE CONNECTOR ACCORDING TO MANUFACTURER'S DESIGN, BUT PEA RESERVES THE RIGHT TO CONSIDER.
4. FOUR (4) CIRCUITS FOR 1,500 kVA TRANSFORMER
5. SIX (6) CIRCUITS FOR 2,000 kVA TRANSFORMER

not to scale

<p>กองข้อกำหนดทางเทคนิค ฝ่ายวิศวกรรม</p>	<h2>การไฟฟ้าส่วนภูมิภาค</h2>	<p>SA4-015/28006 SA4-015/29013 SA4-015/45002</p>
<p>ผู้เขียน... นายสุชา ผู้สำรวจ วิศวกร... ส.ส. ส. หัวหน้าแผนก... <i>S. S. S.</i></p>	<p>รายละเอียดของหัวต่อสายแรงต่ำสำหรับ หม้อแปลงไฟฟ้า สามเฟส 1,500-2,000 kVA</p>	<p>ถูกแทนโดยแบบ..... เขียนเสร็จวันที่ 19 พ.ย. 47 แก้ไขวันที่ 12 พ.ย. 62 ชนิดเป็น... มีสติ๊กเกอร์</p>
<p>ผู้อำนวยการกอง... <i>S. S. S.</i></p>	<h3>DETAIL OF L.V. TERMINAL PADS FOR</h3>	<p>มาตรฐานส่วน..... แบบเลขที่ SA4-015/47002</p>