



PROVINCIAL ELECTRICITY AUTHORITY

TECHNICAL SPECIFICATION DIVISION

SINGLE-PHASE TRANSFORMERS FOR 22 kV and 33 kV 50 Hz DISTRIBUTION SYSTEMS

WITH ABILITY TO WITHSTAND SHORT CIRCUIT

Specification No. RTRN-047/2561

Approved date : 26/09/2561

Rev. No.: 1

Form No. -

Page 1 of 28

Invitation to Bid No:

C Material, equipment, and specifications for SINGLE-PHASE TRANSFORMERS FOR 22 kV and 33 kV 50 Hz DISTRIBUTION SYSTEMS WITH ABILITY TO WITHSTAND SHORT CIRCUIT

C1 General material and packing instructions

Additional to the general instructions, the following shall be observed:

1a Scope

These specifications cover single-phase transformers, oil-immersed, natural self-cooled, power 30 kVA, designed and constructed to withstand without damage the thermal and dynamic effects of external short circuits, suitable for outdoor installation on 22 kV and 33 kV 50 Hz distribution systems (33 kV distribution system is 19/33 Y kV multi-ground system) .

1b Standards

The transformers shall be manufactured and tested in accordance with the following standards:

Thailand Industrial Standard (TIS)

TIS 384: 2543 Power Transformers

International Electrotechnical Commission (IEC)

IEC 60076-1:2011 Power transformers – Part 1: General

IEC 60076-2:2011 Power transformers – Part 2: Temperature rise for liquid-immersed transformers

IEC 60076-3:2013 Power transformers – Part 3: Insulation levels, dielectric tests and external clearances in air

IEC 60076-5:2006 Power transformers – Part 5: Ability to withstand short circuit

IEC 60296: 2012 Fluids for electrotechnical applications – Unused mineral insulating oils for Transformers and switchgear

International Organization for Standardization

ISO 12944-5:2007 Paints and varnishes - Corrosion protection of steel structures by protective paint systems - Part 5: Protective paint systems

LV bushings shall be in accordance with the DIN 42530. HV bushings shall be in accordance with the DIN 42531.

And all other relevant standards, unless otherwise specified in these specifications.



การไฟฟ้าส่วนภูมิภาค
PROVINCIAL ELECTRICITY AUTHORITY

PROVINCIAL ELECTRICITY AUTHORITY

TECHNICAL SPECIFICATION DIVISION

SINGLE-PHASE TRANSFORMERS FOR 22 kV and 33 kV 50 Hz DISTRIBUTION SYSTEMS

WITH ABILITY TO WITHSTAND SHORT CIRCUIT

Specification No. RTRN-047/2561

Approved date : 26/09/2561

Rev. No.: 1

Form No. -

Page 2 of 28

PEA will accept the transformers and accessories tested in accordance with the later edition of the above standards.

PEA will also accept the type test report in accordance with the previous edition of the above standards, if there is no significant change in any test items or no additional test item(s) compared with the above standards. On the other hand, if there is significant change in any test items or there are any additional test items, the previous edition type test report with the additional test report(s) of the significant change test item(s) and/or additional test item(s) will be also accepted.

1c Principal requirement

1c.1 Service condition and installation

The transformers shall be designed and constructed for outdoor installation on concrete poles and operation under the following conditions:

Altitude	: up to 1,000 m above sea level
Ambient air temperature	: 50°C, maximum
	: 40°C, monthly average, of the hottest month
Relative humidity	: up to 94 %
Climate condition	: tropical climate

1c.2 Rating

1. Rated power

The rated power, on continuous operation, shall be 30 kVA.

2. Rated voltage

The rated voltage of windings is given in **Table 1**.

Table 1 Rated voltage

Rated Primary Voltage	Rated Secondary Voltage
22 kV, 19 kV	480/240 V

3. Rated frequency: 50 Hz

1c.3 Core and winding

The transformer cores shall be according to manufacturer's standard.

HV and LV windings of transformers shall be made of copper.

1c.4 Tappings

The primary windings of transformers shall be provided with full capacity of off-circuit tap changer. The tap changer shall be immersed in oil with externally-operated handle.

Tapping range: $\pm 2 \times 2.5\%$ of rated primary voltage

The externally-operated off-circuit tap changer shall be designed for de-energized operation with the operating handle brought out through the wall of the tank. The operating handle shall be fixed to the tank wall on the dividing line between segment 2 and 3, with a tolerance of ± 45 degrees as shown in

Figure 1.

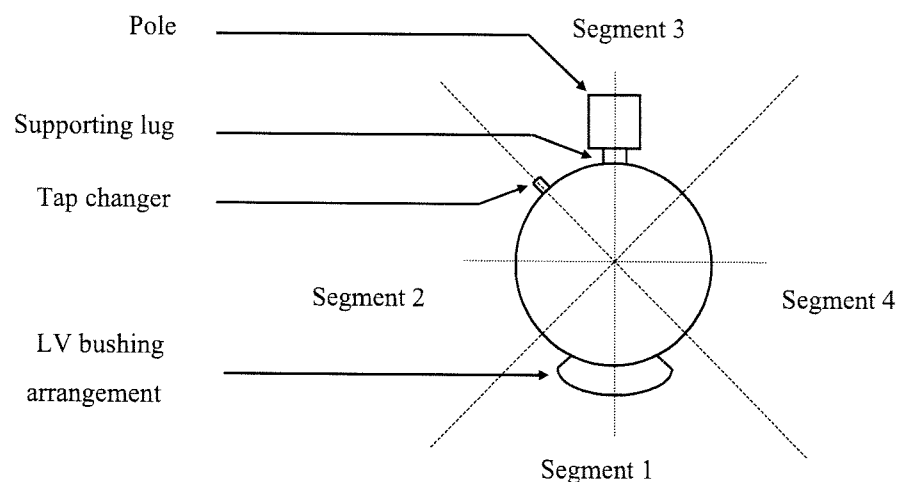

Figure 1 The externally-operated off-circuit tap changer

The tap changer shall have a locking device to prevent improper use. The operating handle shall be rotated in clockwise direction from a high tap voltage to a lower tap voltage. The tap changer shall be provided with stops to identify the highest and lowest tap position. The tap changer positions shall be identified by the numbers in sequence. The number "1" shall be designated to the highest tap voltage. Consequently the number "5" indicates the lowest tap voltage. These identifications shall be in perfect correspondence to those indicated in the connection diagram on the nameplate. All five positions of the tap changer shall be operative positions.

The tap positions shall be indelibly marked with weather-proof paint and in a colour which shall present distinctive contrast to the surrounding material.

The operating handle of tap changer shall be made by non-corrosion metal. Plastic is not acceptable.

1c.5 Polarity: subtractive



SINGLE-PHASE TRANSFORMERS FOR 22 kV and 33 kV 50 Hz DISTRIBUTION SYSTEMS

WITH ABILITY TO WITHSTAND SHORT CIRCUIT

Specification No. RTRN-047/2561

Approved date : 26/09/2561

Rev. No.: 1

Form No. -

Page 4 of 28

1c.6 Losses and Short-circuit impedance

The specified or guaranteed losses plus positive tolerance, for each transformer unit, shall not be more than the figures in the table below.

Short-circuit impedance shall be measured on the principle tapping of 22 or 33 kV at ambient temperature then corrected to 75°C.

Short-circuit impedance of the offered transformer shall be as specified in the **Table 2** and have tolerance within $\pm 10\%$.

Table 2 Losses and Short-circuit impedance

Transformer Rating kVA	Watt Losses		Per cent Short-circuit impedance at 75°C
	No-load loss for system voltage of :	Load loss at 75°C	
	22 kV and 19/33 Y kV		
30	120	430	2.0

1c.7 Limits of temperature-rise, above 50°C ambient temperature

Of top oil : not exceeding 50 K

Of winding : not exceeding 55 K

1c.8 Insulation level

The insulation level of HV windings, LV windings and connected parts of transformers shall be as specified in the **Table 3**.

Table 3 Insulation level

Nominal System Voltage (kV, r.m.s.)	Insulation level	
	Impulse Test Voltage Full Wave (kV, peak)	Power Frequency Test Voltage, 1-min (kV, r.m.s.)
22	125	50
19/33 Y	170	70
0.48/0.24	30	10

Insulation of transformer winding shall be designed uniformly.

1c.9 Bushings

1. Number and location

Each 22 kV transformer shall have two (2) high-voltage bushings located on the cover of the tank and four (4) low-voltage bushings located on the side wall of the tank.

Each 19 kV transformer shall have one (1) high-voltage bushing located on the cover of the tank and four (4) low-voltage bushings located on the side wall of the tank.

The HV bushings shall not be completed with the arcing horns.

2. Material

Transformer bushings shall be made of good commercial-grade wet-process porcelain.

The entire porcelain surface of the bushings that will be exposed after assembly shall be glazed.

The colour of the glaze shall be brown.

3. Electrical characteristics

Transformer bushings shall be capable of withstanding the impulse and low-frequency voltage as specified in the **Table 4**.

Table 4 Electrical characteristics

Bushing	Impulse Full Wave (kV, peak)	Low-frequency, 50 Hz (kV, r.m.s.)	
		Dry 1-minute	Wet 10-second
High-voltage bushings for 22 kV system	125	50	50
High-voltage bushings for 19/33 Y kV system	170	70	70
Low-voltage bushings	30	10	10

4. Minimum Clearance

Safety clearance of Transformer bushings shall comply with minimum Clearance Criterion, which measurement between live part to live part or live part to ground shall be as follows.

- At least 225 mm for 22 kV System.
- At least 320 mm for 19/33 kV System.

5. Test report

The bidders have to submit the test report of bushing with the bid in order to confirm the electrical characteristic in **Table 4 Electrical characteristics**, the bidders who cannot submit will be rejected. The test of bushing can be conducted by manufacturer or third party laboratories.



การไฟฟ้าส่วนภูมิภาค
PROVINCIAL ELECTRICITY AUTHORITY

PROVINCIAL ELECTRICITY AUTHORITY

TECHNICAL SPECIFICATION DIVISION

SINGLE-PHASE TRANSFORMERS FOR 22 kV and 33 kV 50 Hz DISTRIBUTION SYSTEMS

WITH ABILITY TO WITHSTAND SHORT CIRCUIT

Specification No. RTRN-047/2561

Approved date : 26/09/2561

Rev. No.: 1

Form No. -

Page 6 of 28

1c.10 Terminal connectors

HV bushings shall be equipped with solderless clamp type connectors for aluminium conductor diameter range from 7.5 mm to 12.6 mm (sizes 35-95 mm²).

LV bushings shall be equipped with terminal pad connectors in vertical (stud type connectors are preferable), of high conductivity bronze and hot-tin dipped. The terminal pads shall be drilled in accordance with NEMA Standards (9/16" holes on 1 3/4" centers); each hole shall be furnished with one (1) bolt M 12 x 60 mm (of at least 50 mm thread length), one (1) nut, two (2) flat washers, and one (1) lock washer. The connector shall be provided with mounting hardware of stainless steel or better. The details of terminal pads shall be according to Drawing No. SA4-015/45001.

1c.11 Tank and tank finish

Tank and cover shall be constructed of welded steel plate suitable reinforced. The joints between the tank and cover shall be provided with suitable flanges properly bolted together with gaskets.

Tank cover shall have 90° downward bent edges on all sides to protect the gasket under the top cover from direct exposure to weather.

Gaskets between metal surfaces shall be set in grooves or held in position by retainers so arranged that all parts are bolted metal-to-metal. The gaskets shall be made of resilient material which will not deteriorate under the action of hot oil and will remain oil-tight. Gaskets of such material which can be easily damaged by overpressing are not acceptable.

The transformer tank shall be round or oblique round shape, but round shape is preferable.

The transformer tank shall be furnished with mounting bracket for surge arrester. (Surge arresters shall be supplied by PEA), see Drawing No. SA4-015/50007.

The bidders have to give the transformer's tank dimensions which passed type test in **2a Performance data and guarantee of the single-phase transformer** (Page 25 of 28).

Tolerance of the transformer's tank dimensions for the purposed transformer shall be within ± 3 percent of the declared dimensions which given by the bidders in above information, Otherwise shall be rejected.

The tank shall have rolled edge base and recessed bottom of not less than 20.0 mm in order to facilitate the fixing of bracket for transformer secondary leads, see Drawing No. SA2-015/26028.

The manufacturer's serial number shall be dented on transformer tank cover.

The manufacture shall prepare 3 mm diameter holes for security seals threading. The first position, the hole shall be drilled at the right last bolt which fix tank and cover of transformer and the second position, the hole shall be drilled at the top right of transformer nameplate as **Figure 2**.



การไฟฟ้าส่วนภูมิภาค
PROVINCIAL ELECTRICITY AUTHORITY

PROVINCIAL ELECTRICITY AUTHORITY

TECHNICAL SPECIFICATION DIVISION

SINGLE-PHASE TRANSFORMERS FOR 22 kV and 33 kV 50 Hz DISTRIBUTION SYSTEMS

WITH ABILITY TO WITHSTAND SHORT CIRCUIT

Specification No. RTRN-047/2561

Approved date : 26/09/2561

Rev. No.: 1

Form No. -

Page 7 of 28

The security seals will be installed by PEA after any transformers pass the witness test or acceptance test or others depend on PEA's committee.

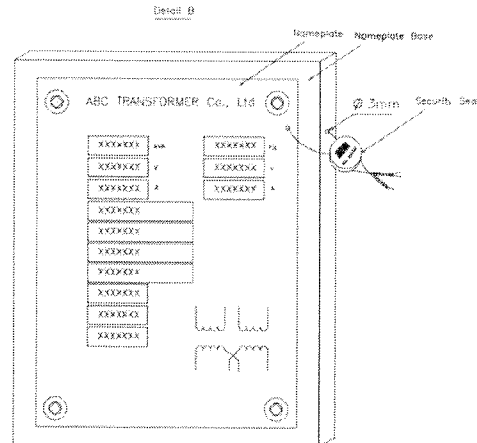
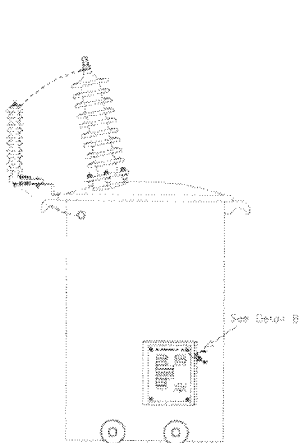
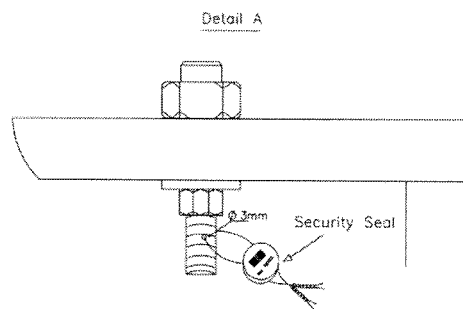
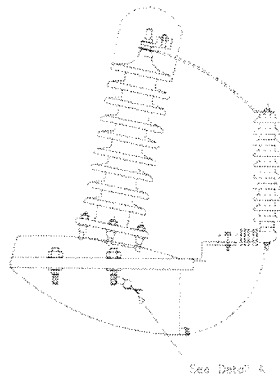

Note : The hole shall be drilled by manufacturer and thread with security seal by PEA

Figure 2 Security seal installation

1c.11.1 Painting system

1. Interior surface

Interior surface shall be finished oil resistant paint or varnish.

2. Exterior surface

The painting system will be suitable for an exterior servicing at medium atmospheric-corrosivity category is as C3, and system number is as A.3.09 which is classified as high expected durability (more than 15 years) in accordance with ISO 12944-5 Table A.3.



การไฟฟ้าส่วนภูมิภาค
PROVINCIAL ELECTRICITY AUTHORITY

PROVINCIAL ELECTRICITY AUTHORITY

TECHNICAL SPECIFICATION DIVISION

SINGLE-PHASE TRANSFORMERS FOR 22 kV and 33 kV 50 Hz DISTRIBUTION SYSTEMS

WITH ABILITY TO WITHSTAND SHORT CIRCUIT

Specification No. RTRN-047/2561

Approved date : 26/09/2561

Rev. No.: 1

Form No. -

Page 8 of 28

The coating system shall be in accordance with the ISO 12944-5 as following:

- Primer coat: The number of coat is one (1) coat of Epoxy (Misc) Anti-Corrosive Primer, the dry film thickness shall not less than 80 μm
- Subsequent coat(s): The number of coats are two (2) to four (4) of Epoxy Intermediate and Polyurethane topcoat with RAL 7036 gray color.
- The total number of coats are three (3) to five (5) coats and the dry film thickness of coating system shall not less than 200 μm .

3. Dry film thickness test and test report

The dry film thickness shall be spot checked for each layer of coating. The position of spot checks is specified as **Figure 3** and **Figure 4**.

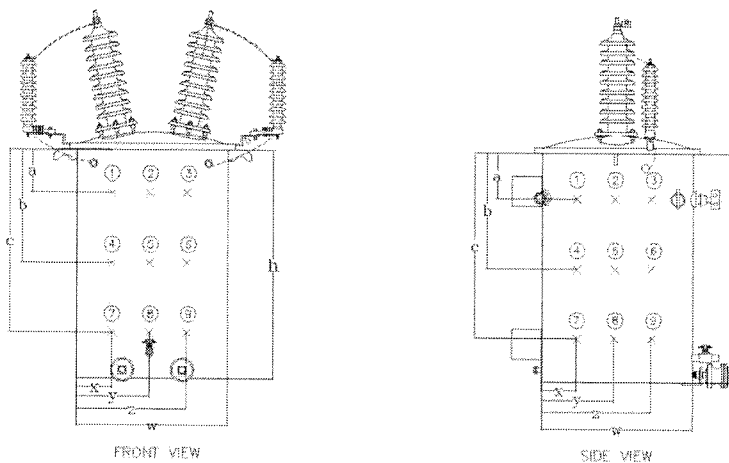

Figure 3: The position of spot checking for 22 kV single-phase transformers.

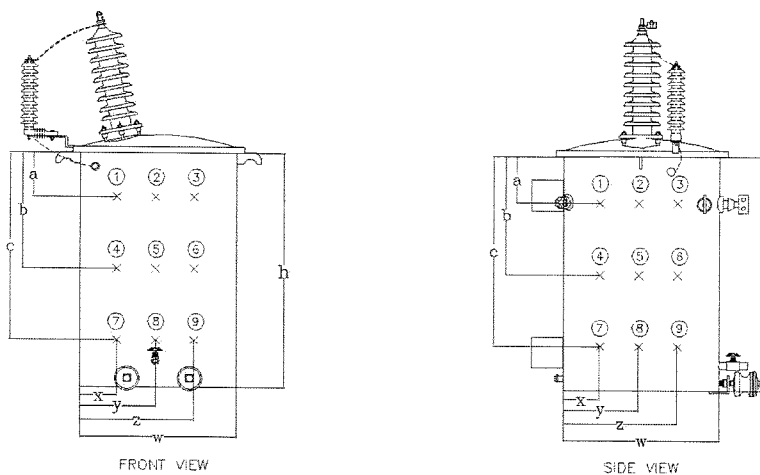

Figure 4: The position of spot checking for 19 kV single-phase transformers.



การไฟฟ้ช้ล้กัลว้ณล้กัลล้กัล
PROVINCIAL ELECTRICITY AUTHORITY

PROVINCIAL ELECTRICITY AUTHORITY

TECHNICAL SPECIFICATION DIVISION

SINGLE-PHASE TRANSFORMERS FOR 22 kV and 33 kV 50 Hz DISTRIBUTION SYSTEMS

WITH ABILITY TO WITHSTAND SHORT CIRCUIT

Specification No. RTRN-047/2561

Approved date : 26/09/2561

Rev. No.: 1

Form No. -

Page 9 of 28

The distance for spot checking is specified in Table 5:

Table 5 Distance for spot checking

Symbols	Distance
a	About 25% of height (h)
b	About 50% of height (h)
c	About 75% of height (h)
x	About 25% of width (w)
y	About 50% of width (w)
z	About 75% of width (w)

The bidders have to submit the test report, conducted by the acknowledged testing laboratories or manufacture, with the bid. The Item offered without submitting the dry film thickness test report shall be rejected.

The cost of all tests and reports shall be borne by the bidders/manufacturers/contractor.

1c.11.2 Dry film thickness test report

The required information in dry film thickness test report shall be at least the following items:

(1) Transformer information

- Manufacturer's name
- Model
- Serial number
- Number of phase
- Rated voltage of the high-voltage winding
- Rated voltage of the low-voltage winding
- Rated frequency
- Rated power
- Rated current of the high-voltage winding
- Rated current of the low-voltage winding

(2) Painted information

- Coating system (flow coating or spraying)
- The information for each coating (Primer coat, Subsequent coat, Top coat) as following:
 - Type of material
 - Paint Manufacturer
 - Require minimum dry film thickness (μm) as specified
 - Actual dry film thickness (μm) (3 reading per 1 spot checks)



การไฟฟ้าส่วนภูมิภาค
PROVINCIAL ELECTRICITY AUTHORITY

PROVINCIAL ELECTRICITY AUTHORITY

TECHNICAL SPECIFICATION DIVISION

SINGLE-PHASE TRANSFORMERS FOR 22 kV and 33 kV 50 Hz DISTRIBUTION SYSTEMS

WITH ABILITY TO WITHSTAND SHORT CIRCUIT

Specification No. RTRN-047/2561

Approved date : 26/09/2561

Rev. No.: 1

Form No. -

Page 10 of 28

1c.11.3 Acceptance test procedure of dry film thickness test

The total dry film thickness of coating shall be measured by contractor for acceptance testing and witness by the PEA's acceptance committee. Total dry film thickness shall be not less than 200 μm according to ISO 12944-5. PEA will randomly select the samples of transformer only from the first lot. The number of sample and criteria for consideration shall be according to **Table 6**.

PEA reserve the right to send representative to inspect and witness test.

The cost of all tests and reports shall be borne by the manufacturers/contractor.

1c.12 Marking

PEA's code number and word "**SHORT CIRCUIT WITHSTAND**" shall be painted, in orange, on the transformer tank (for transformer having no conservator) or on the conservator tank (for transformer having conservator) at the position that enables a clear observation, and also be legibly and durably inscribed on the metal part of nameplate. The code number and dimensions of each letter to be marked shall be given by PEA after the final of bid consideration.

1c.13 Accessories

Each transformer shall be furnished and equipped with the following accessories:

1. HV and LV bushings, with terminal connectors
2. Bird guard cap (bushing cover), ultra-violet and track resistant material, e.g. polypropylene, neoprene, etc; which is suitable for exposure to sunlight
3. Tap changer
4. Nameplate with connection diagram
5. Oil drain valve with plug or cap, installed at the lower part of the tank.
6. Earthing terminal, with eye-bolt type connector suitable for steel stranded conductor diameter of 9.0 mm (size 50 mm²); complete with lock washer of stainless steel or better
7. Lifting lugs
8. Supporting lugs for hanging the transformer tank to pole by using two (2) M 16 machine bolts; the lugs are 500 mm apart
9. Oil-level marking inside the tank
10. Earthing terminal for surge arrester, with solderless clamp type connector suitable for flexible copper insulated ground lead size 16 mm², 430 mm long. (See drawing SA4-015/50007)
11. Compression type cable lug, for aluminium conductor diameter of 7.5-9.0 mm (sizes 35-50 mm²), suitable for connecting between HV bushing and surge arrester lead conductor
12. Other necessary accessories according to manufacturer's design



PROVINCIAL ELECTRICITY AUTHORITY

TECHNICAL SPECIFICATION DIVISION

SINGLE-PHASE TRANSFORMERS FOR 22 kV and 33 kV 50 Hz DISTRIBUTION SYSTEMS

WITH ABILITY TO WITHSTAND SHORT CIRCUIT

Specification No. RTRN-047/2561

Approved date : 26/09/2561

Rev. No.: 1

Form No. -

Page 11 of 28

1c.14 Initial oil filling

The transformers shall be supplied with initial oil filling. The oil shall be according to IEC 60296, high-quality, clean and dry.

The oil shall be free from Polychlorinated Biphenyls (PCBs).

1c.15 Nameplate

The following minimum nameplate information shall be legibly and durably inscribed on the metal part of nameplate.

- (1) Manufacturer's name
- (2) Manufacturer's serial number
- (3) Year of manufacture
- (4) PEA's code number
- (5) Contract number and/or PO number
- (6) Number of phases
- (7) Rated frequency in Hz
- (8) Rated output in kVA
- (9) Rated voltage in V
- (10) Rated current in A
- (11) Tap voltages in V
- (12) Polarity
- (13) Per cent short-circuit impedance
- (14) Connection diagram
- (15) Type of cooling
- (16) Oil quantity in liter
- (17) Total weight in kg
- (18) Winding material (Made of copper)
- (19) Rated secondary short-circuit withstand current in kA r.m.s.
- (20) Wording "**SHORT CIRCUIT WITHSTAND**"



การไฟฟ้าส่วนภูมิภาค
PROVINCIAL ELECTRICITY AUTHORITY

PROVINCIAL ELECTRICITY AUTHORITY

TECHNICAL SPECIFICATION DIVISION

SINGLE-PHASE TRANSFORMERS FOR 22 kV and 33 kV 50 Hz DISTRIBUTION SYSTEMS

WITH ABILITY TO WITHSTAND SHORT CIRCUIT

Specification No. RTRN-047/2561

Approved date : 26/09/2561

Rev. No.: 1

Form No. -

Page 12 of 28

1c.16 Terminal markings and connection diagrams

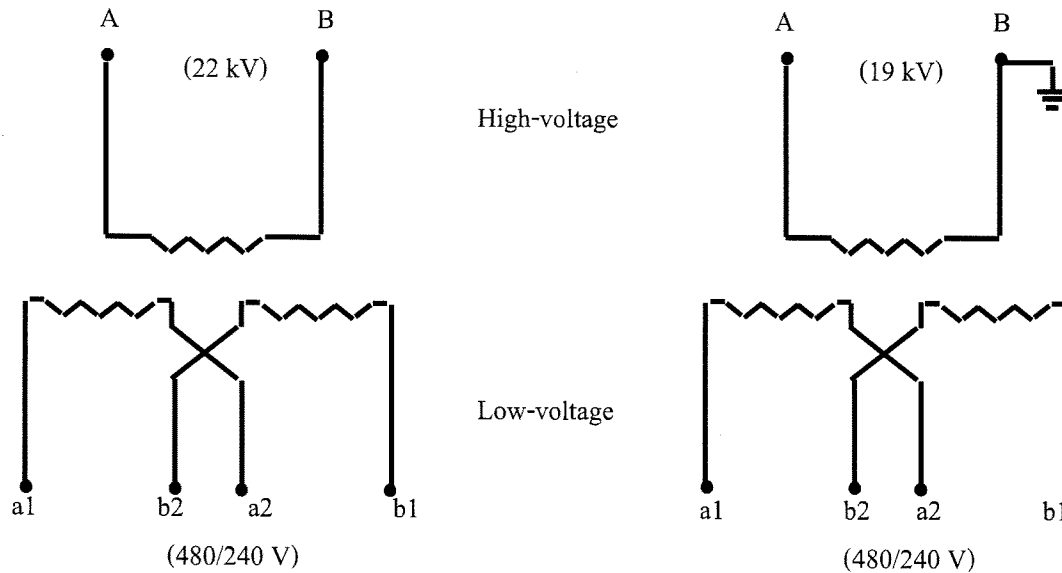

Figure 5 Terminal markings and connection diagrams

The symbols, A, B, a₁, a₂, b₁, and b₂, shall be durable marked on transformer tank beside bushings consequently. The height of the symbols shall not less than 30 mm.

Mark by sticker is not accepted.

1c.17 Mass

Mass of complete transformer with oil and accessories shall not be more than 1,000 kg.

Tolerance of the mass of proposed complete transformers with oil shall be within ± 5 percent of the declared mass of transformer which passed type test given by the bidders in 2a Performance data and guarantee of single-phase transformer (Page 25 of 28) but the maximum mass shall not exceed 1,000 kg.

If the mass of complete transformers with oil more than ± 5 percent of the declared mass or exceed the above allowable mass, the transformers shall be rejected.

1d Packing

For transformers manufactured outside the territories of Thailand, one (1) transformer or two (2) transformers shall be seaworthy packed in an export crate or wooden case which will not be returned.

For transformers manufactured within the territories of Thailand, one (1) transformer or two (2) transformers shall be packed in a crate or wooden case which will not be returned.

Each crate or wooden case shall be strong enough for stacking over with at least another one.

If the crate or wooden case is made of rubber wood (Yang-para), the wooden parts shall be treated with wood preservative. The details of wood treatment shall be described.



PROVINCIAL ELECTRICITY AUTHORITY

TECHNICAL SPECIFICATION DIVISION

SINGLE-PHASE TRANSFORMERS FOR 22 kV and 33 kV 50 Hz DISTRIBUTION SYSTEMS

WITH ABILITY TO WITHSTAND SHORT CIRCUIT

Specification No. RTRN-047/2561

Approved date : 26/09/2561

Rev. No.: 1

Form No. -

Page 13 of 28

1e Tests and test reports

1e.1 Routine test

Each transformer shall pass the manufacturer's standard routine tests, and also pass the following tests in accordance with the relevant standards:

- (1) Measurement of winding resistance (IEC 60076-1)
- (2) Measurement of voltage ratio and check of phase displacement (IEC 60076-1)
- (3) Measurement of short-circuit impedance and load loss (IEC 60076-1)
- (4) Measurement of no-load loss and current (IEC 60076-1)
- (5) Dielectric routine tests (IEC 60076-1 and IEC60076-3)

The Item offered without submitting the list of routine test shall be rejected.

1e.2 Type test and Short-circuit withstand test

The following type tests shall be in accordance with the relevant standards:

- (1) Temperature-rise test (IEC 60076-2)
- (2) Dielectric type tests (IEC 60076-1 and IEC 60076-3)
- (3) Measurement of no-load loss and current at 90 % and 110 % of rated voltage (IEC 60076-1)
- (4) Short-circuit withstand test (IEC 60076-5)

Type test and short-circuit withstand test shall be made on only one (1) unit of each rating.

The transformers shall be passed all items of the type test and short-circuit withstand test, conducted or inspected by one (1) acknowledged independent testing laboratory according to **1e.3 Acknowledged independent testing laboratories** and the test result shall be included in one (1) test report.

The test report shall be issued or approved by the same acknowledged independent testing laboratory according to **1e.3 Acknowledged independent testing laboratories**, otherwise will be rejected.

The bidders have to submit the type test and short-circuit withstand test report with the bid.

The type test and short-circuit withstand test report of the transformers which are conducted or inspected by Thailand's national laboratories/institutes shall be valid within five (5) years count from the issued date in the test reports to the bid closing date.

For the type test and short-circuit withstand test report of the transformers which are conducted or inspected by laboratories/institutes, with in other countries shall be valid within ten (10) years count from the issued date in the test reports to the bid closing date.



PROVINCIAL ELECTRICITY AUTHORITY

TECHNICAL SPECIFICATION DIVISION

SINGLE-PHASE TRANSFORMERS FOR 22 kV and 33 kV 50 Hz DISTRIBUTION SYSTEMS

WITH ABILITY TO WITHSTAND SHORT CIRCUIT

Specification No. RTRN-047/2561

Approved date : 26/09/2561

Rev. No.: 1

Form No. -

Page 14 of 28

PEA will also accept other documents instead of the type test and short-circuit withstand test reports in the following conditions:

- (1) In case the proposed transformer has been supplied to PEA and get the order from PEA's Procurement Department or Substation Work Department or Transmission and Distribution System Work Department (from PEA's head office), the Purchase Order (PO) or Contract with List of suppliers or Proposal form can be submitted, or
- (2) In case the proposed transformer has been registered for PEA Product Acceptance, the not-expired registration certificate counted to the bid closing date can be submitted, or
- (3) In case the proposed transformer has been registered for Product lists for substation turnkey project, the not-expired registration certificate counted to the bid closing date can be submitted instead

However the document in case (1), (2) and (3) shall be proved that the transformer specified in the PO or Contract with List of suppliers or Proposal form or registration certificate shall be the same product, type/model and all ratings as the proposed transformer for this bid.

The cost of all tests and reports shall be borne by the bidders/manufacturers/contractor.

1e.2.1 Short-circuit withstand test criteria

The transformers shall be designed and constructed to withstand without damage by the thermal and dynamic effects of the external short circuit in accordance with the IEC 60076-5.

The duration of the current I to be used for the calculation of the thermal ability to withstand short circuit shall be 2 s and the initial temperature for calculation shall be 105°C.

The ability to withstand the dynamic short circuit shall be demonstrated by test, comparison method is not acceptable. Test procedure of short-circuit withstand test shall be according to **1e.2.2 Test procedure of Type test and Short-circuit withstand test.**

The total number of tests shall be three made in a different position of the tap-changer according to IEC 60076-5. The duration of each test shall be 0.5 s

The bidders have to submit the short circuit test report of the identical transformers (purchased transformer) with the bid, otherwise shall be not accepted.

1e.2.2 Test procedure of Type test and Short-circuit withstand test

Each transformer, as delineated by its own unique serial number, is required to pass a complete type test and short-circuit withstand test following the procedures listed below:

- (1) Prior to short circuit testing, each individual transformer must pass the routine test, measurement of no-load loss and current at 90 % and 110 % of rated voltage and temperature-rise tests. Criteria for the temperature-rise test is presented in **1c.7 "Limits of temperature-rise"**